

# Dell Vostro 15-7570

## Owner's Manual



## Notes, cautions, and warnings

 **NOTE:** A NOTE indicates important information that helps you make better use of your product.

 **CAUTION:** A CAUTION indicates either potential damage to hardware or loss of data and tells you how to avoid the problem.

 **WARNING:** A WARNING indicates a potential for property damage, personal injury, or death.

© 2017 Dell Inc. or its subsidiaries. All rights reserved. Dell, EMC, and other trademarks are trademarks of Dell Inc. or its subsidiaries. Other trademarks may be trademarks of their respective owners.

# Chassis

This chapter illustrates the multiple chassis' view along with the ports and connectors and also explains the function hot key combinations.

Topics:

- Front open view
- Left view
- Right view
- Palmrest view
- Back view
- Bottom view
- Keyboards hot key definitions

## Front open view

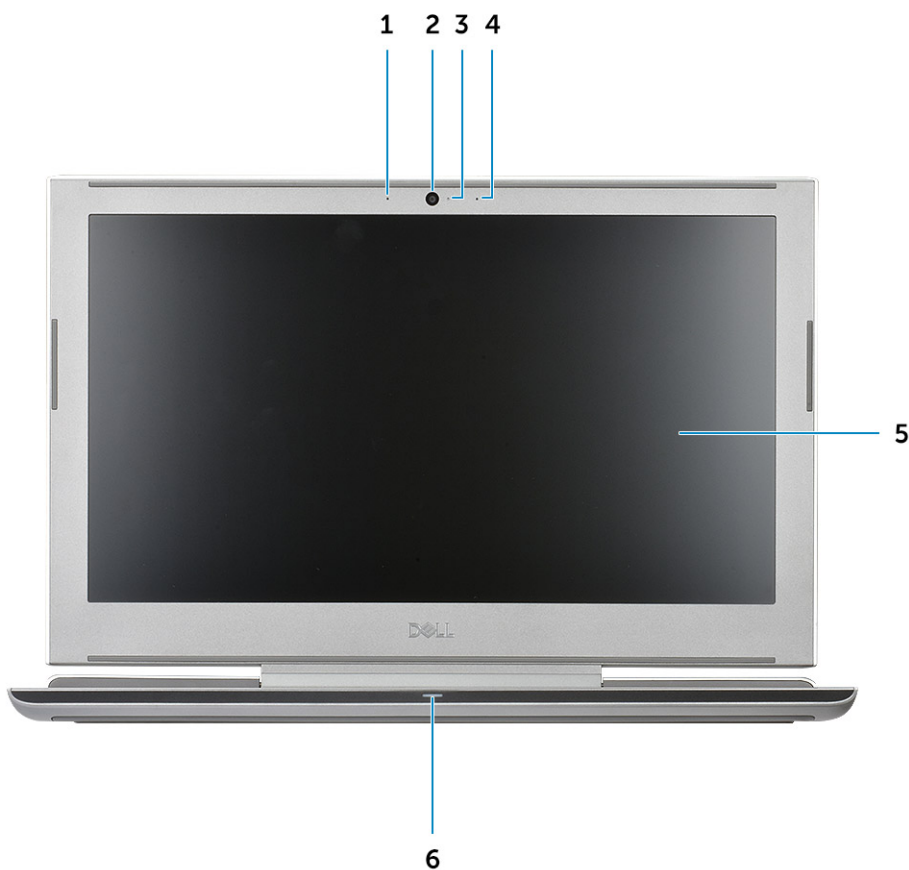

1 Dual array microphones

2 Camera



- 3 Camera status light
- 5 Display panel

- 4 Dual array microphones
- 6 LED status light

## Left view

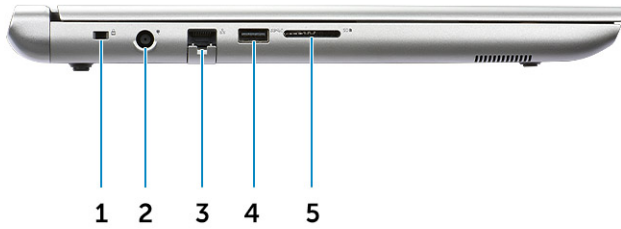

- 1 Nobel Wedge lock slot
- 3 Network connector
- 5 SD card reader

- 2 Power connector
- 4 USB 3.1 Gen 1 port

## Right view

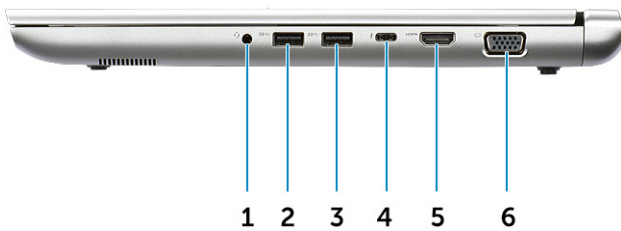

- 1 Headset/Mic port
- 3 USB 3.1 Gen 1 port
- 5 HDMI port

- 2 USB 3.1 Gen 1 port
- 4 USB Type-C port with Thunderbolt 3
- 6 VGA port



# Palmrest view

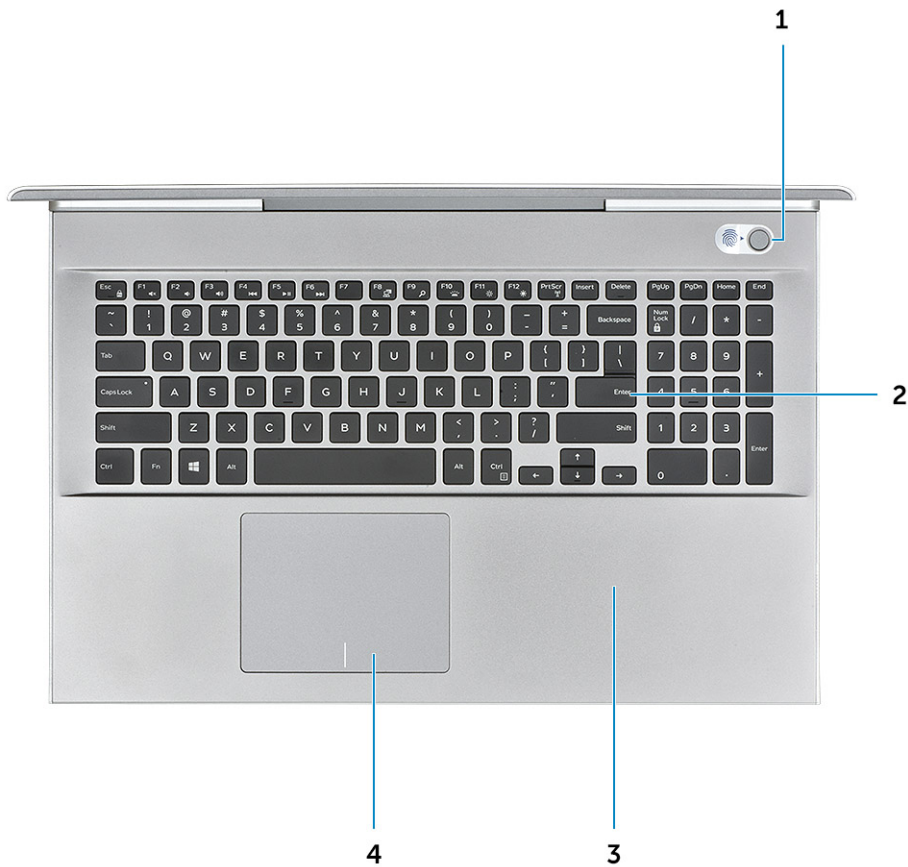

- 1 Power button/Fingerprint reader
- 3 Palmrest

- 2 Keyboard
- 4 Touchpad

## Back view



1 Air vent

2 Air vent

## Bottom view

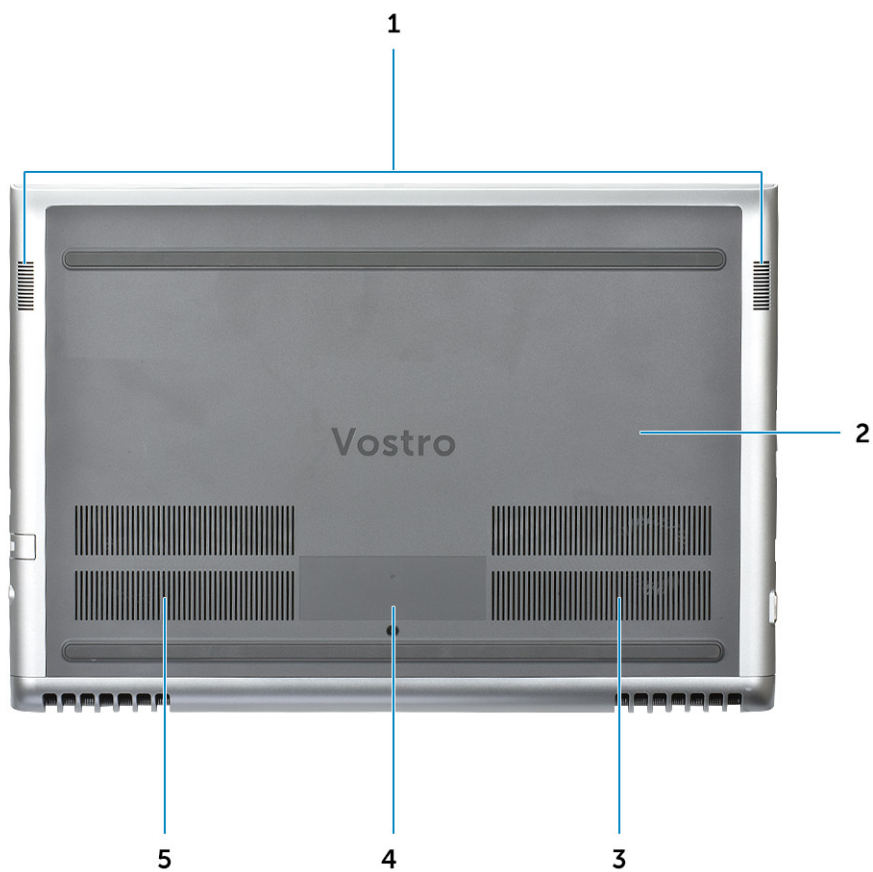

- 1 Speakers
- 3 Air vent
- 5 Air vent

- 2 Back cover
- 4 Service tag label

# Keyboards hot key definitions

**Table 1. Keyboard hot key combination**

Fn Key Combination	Function
Fn+ESC	Fn Toggle
Fn+ F1	Speaker Mute
Fn + F2	Volume Down
Fn + F3	Volume Up
Fn + F4	Previous track
Fn + F5	Play/Pause
Fn + F6	Next track
Fn + F8	Extend display
Fn + F9	Search
Fn + F10	Increase Keyboard Backlight Brightness  (Pressing this function cycles keyboard backlight to the next level in the sequence: 50%, 100%, off)
Fn + F11	Decrease brightness
Fn + F12	Increase brightness
Fn + PrtScr	Turn off/on wireless



# Removing and installing components

This section provides detailed information on how to remove or install the components from your computer.

## Recommended tools

The procedures in this document require the following tools:

- Phillips #0 screwdriver
- Phillips #1 screwdriver
- Plastic scribe

**NOTE:** The #0 screw driver is for screws 0-1 and the #1 screw driver is for screws 2-4

## Before working inside your computer

- 1 Ensure that your work surface is flat and clean to prevent the computer cover from being scratched.
- 2 Turn off your computer.
- 3 If the computer is connected to a docking device (docked), undock it.
- 4 Disconnect all network cables from the computer (if available).

**CAUTION:** If your computer has an RJ45 port, disconnect the network cable by first unplugging the cable from your computer.

- 5 Disconnect your computer and all attached devices from their electrical outlets.
- 6 Open the display.
- 7 Press and hold the power button for few seconds, to ground the system board.

**CAUTION:** To guard against electrical shock unplug your computer from the electrical outlet before performing Step # 8.

**CAUTION:** To avoid electrostatic discharge, ground yourself by using a wrist grounding strap or by periodically touching an unpainted metal surface at the same time as touching a connector on the back of the computer.

- 8 Remove any installed ExpressCards or Smart Cards from the appropriate slots.

## After working inside your computer

After you complete any replacement procedure, ensure that you connect external devices, cards, and cables before turning on your computer.

**CAUTION:** To avoid damage to the computer, use only the battery designed for this particular Dell computer. Do not use batteries designed for other Dell computers.

- 1 Connect any external devices, such as a port replicator or media base, and replace any cards, such as an ExpressCard.
- 2 Connect any telephone or network cables to your computer.

**CAUTION:** To connect a network cable, first plug the cable into the network device and then plug it into the computer.

- 3 Connect your computer and all attached devices to their electrical outlets.
- 4 Turn on your computer.

# Base cover

## Removing the base cover

- 1 Follow the procedure in [Before working inside your computer](#).
- 2 To remove the base cover:
  - a Loosen the M2.5x2+3.5 captive screws that secure the base cover to the computer [1].
  - b Pry the base cover from the edge [2].

**NOTE:** You may need a plastic scribe to pry the base cover from the edge.



- 3 Lift the base cover away from the computer.



## Installing the base cover

- 1 Align the base cover with the screw holders on the computer.
- 2 Press the edges of the cover until it clicks into place.
- 3 Tighten the M2.5x2+3.5 screws to secure the base cover to the computer.
- 4 Follow the procedure in [After working inside your computer](#).

## Battery

### Removing the battery

- 1 Follow the procedure in [Before working inside your computer](#).
- 2 Remove the [base cover](#).
- 3 To remove the battery:
  - a Disconnect the battery cable from the connector on the system board [1].
  - b Remove the M2x3L screws that secure the battery to the computer [2].

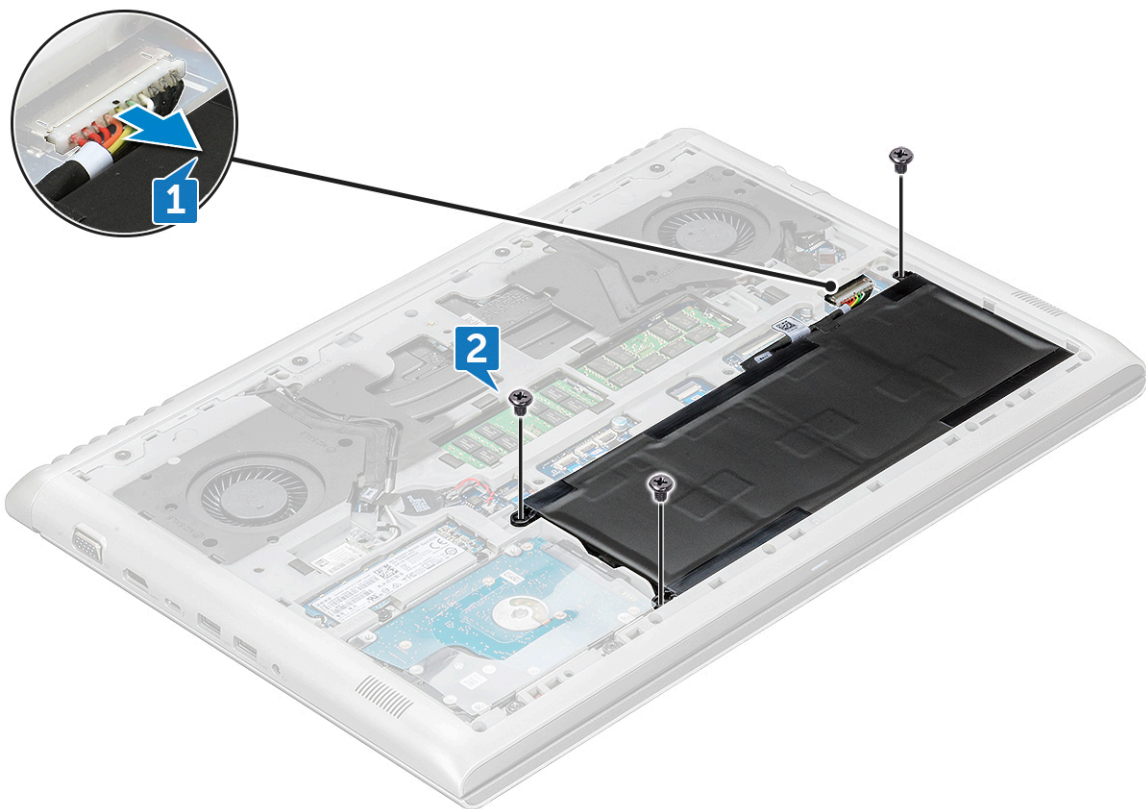

4 Lift the battery away from the computer.

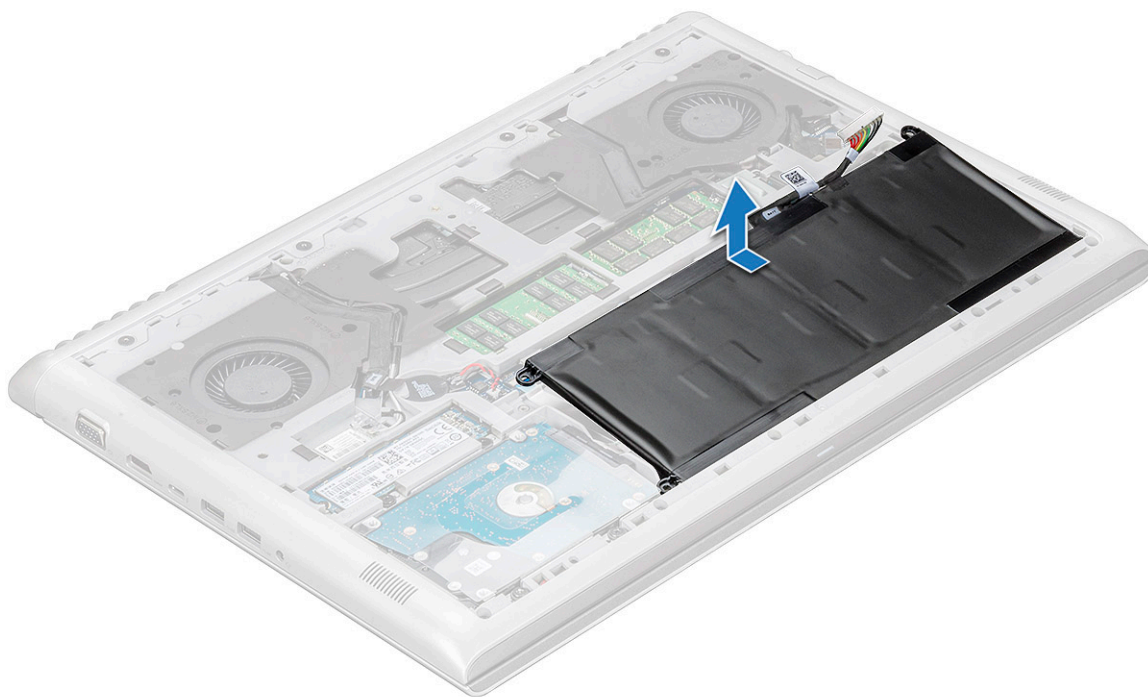

## Installing the battery

- 1 Insert the battery into the slot on the computer.
- 2 Connect the battery cable to the connector on the battery.



- 3 Tighten the M2x3L screws to secure the battery to the computer.
- 4 Install the [base cover](#)
- 5 Follow the procedure in [After working inside your computer](#).

## Coin cell battery

### Removing the coin cell battery

- 1 Follow the procedure in [Before working inside your computer](#).
- 2 Remove the:
  - a [base cover](#)
  - b [battery](#)
- 3 To remove the coin cell battery:
  - a Disconnect the coin cell battery cable from the connector on the system board [1].
  - b Pry the coin cell battery to release from the adhesive and lift it away from the system board [2].



### Installing the coin cell battery

- 1 Place the coin cell battery into the slot on the system board.
- 2 Connect the coin cell battery cable to the connector on the system board.
- 3 Install the:
  - a [battery](#)
  - b [base cover](#)
- 4 Follow the procedure in [After working inside your computer](#).

# Memory modules

## Removing the memory module

- 1 Follow the procedure in [Before working inside your computer](#).
- 2 Remove the:
  - a [base cover](#)
  - b [battery](#)
- 3 To remove the memory module:
  - a Pry the clips securing the memory module until the memory pops-up [1].
  - b Lift the memory module away from the connector [2].

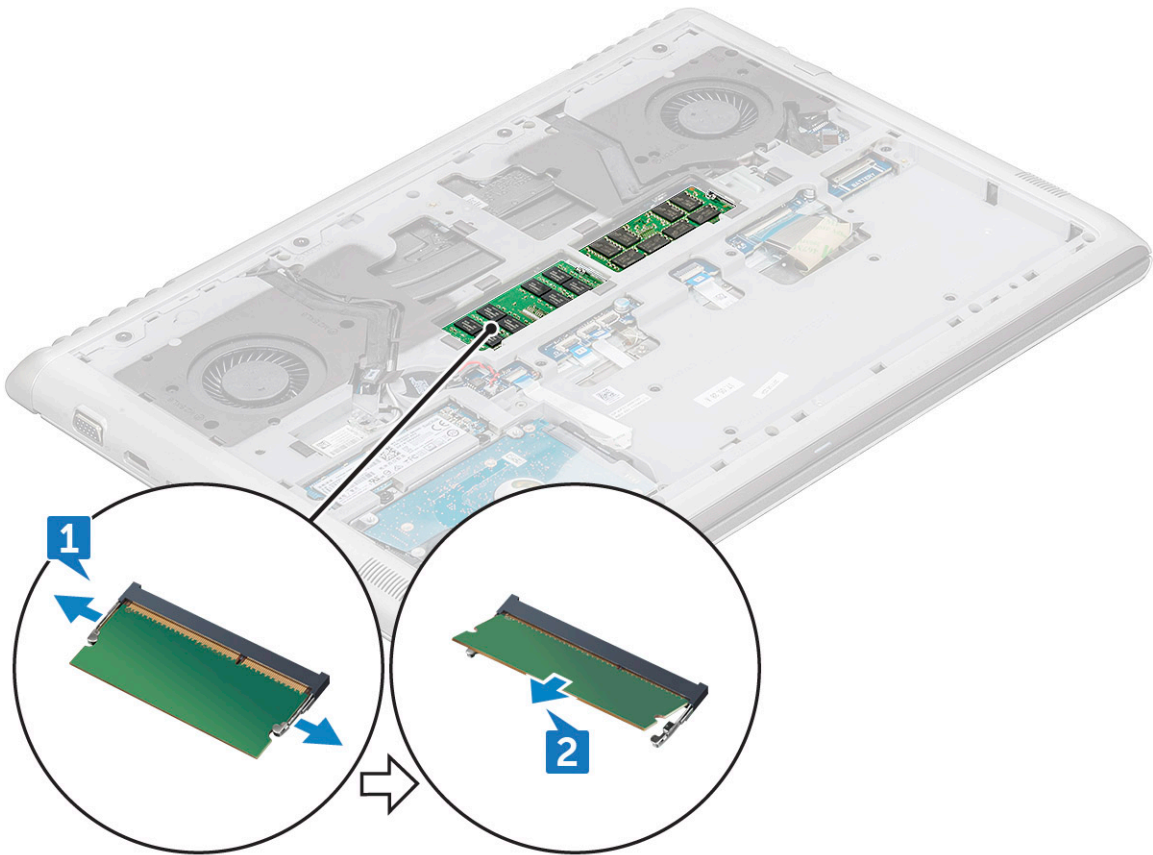

## Installing the memory module

- 1 Insert the memory module into the memory module socket until the clips secure the memory module.
- 2 Install the:
  - a [battery](#)
  - b [base cover](#)
- 3 Follow the procedure in [After working inside your computer](#).



# Hard drive

## Removing the hard drive

- 1 Follow the procedure in [Before working inside your computer](#).
- 2 Remove the:
  - a [base cover](#)
  - b [battery](#)
- 3 To disconnect the cable:
  - a Lift the latch and disconnect the hard drive cable from the computer [1].
  - b Pry the hard drive cable to release from the adhesive [2].

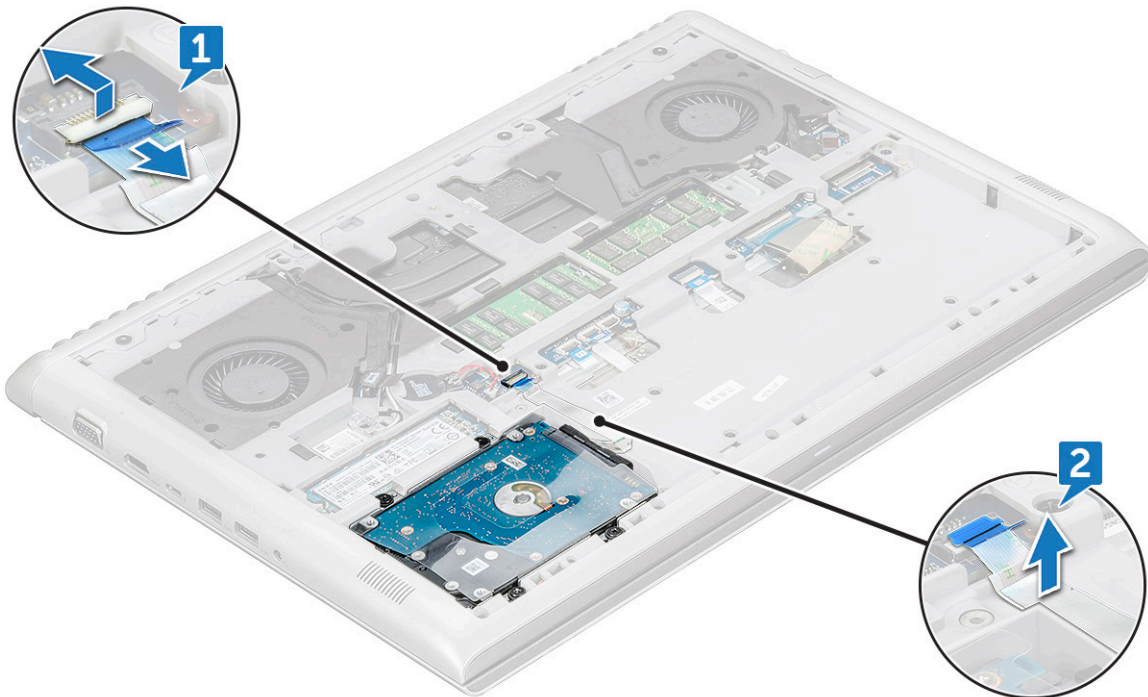

- 4 To remove the hard drive:
  - a Remove the M2.5x5L screws that secure the hard drive to the computer [1].
  - b Lift the hard drive away from the computer [2].

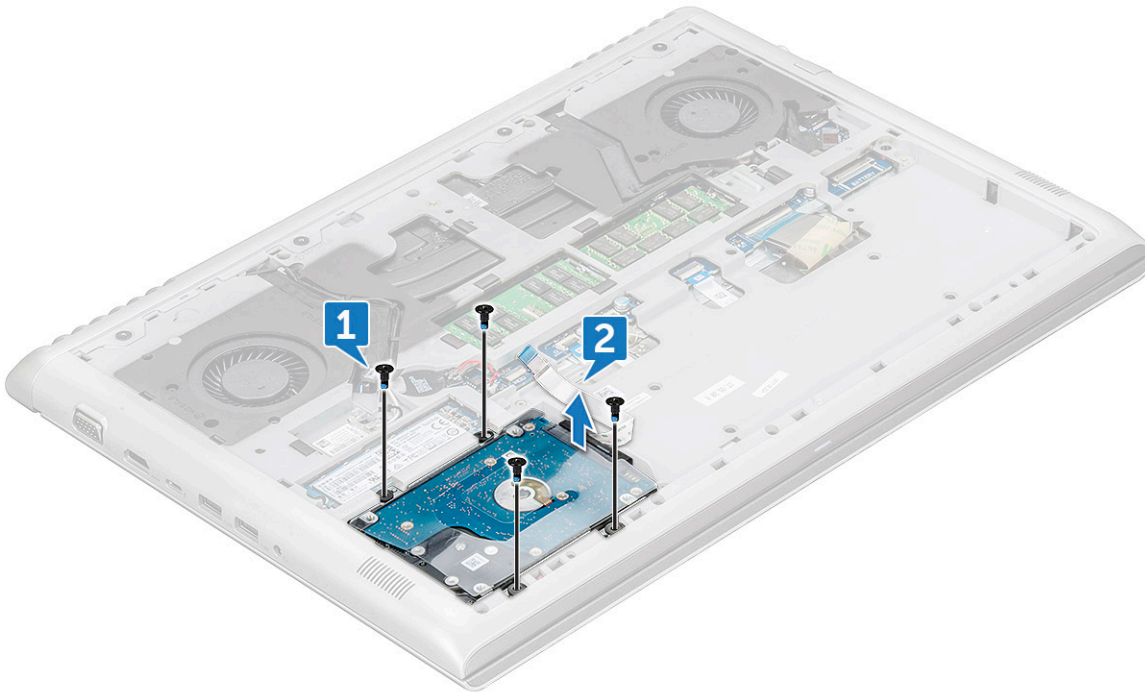

## Installing the hard drive

- 1 Insert the hard drive into the slot on the computer.
- 2 Replace the M2.5x5L screws to secure the hard drive assembly to the computer.
- 3 Affix the hard drive cable on the computer.
- 4 Connect the hard drive cable to the connector on the hard drive and on the system board.
- 5 Install the:
  - a battery
  - b base cover
- 6 Follow the procedure in [After working inside your computer](#).

## Solid State Drive — optional

### Removing the M.2 Solid State Drive — SSD

- 1 Follow the procedure in [Before working inside your computer](#).
- 2 Remove the:
  - a base cover
  - b battery
- 3 To remove the SSD:
  - a Remove the M3x3L screw that secures the SSD to the computer [1].
  - b Slide and lift the SSD from the computer [2].

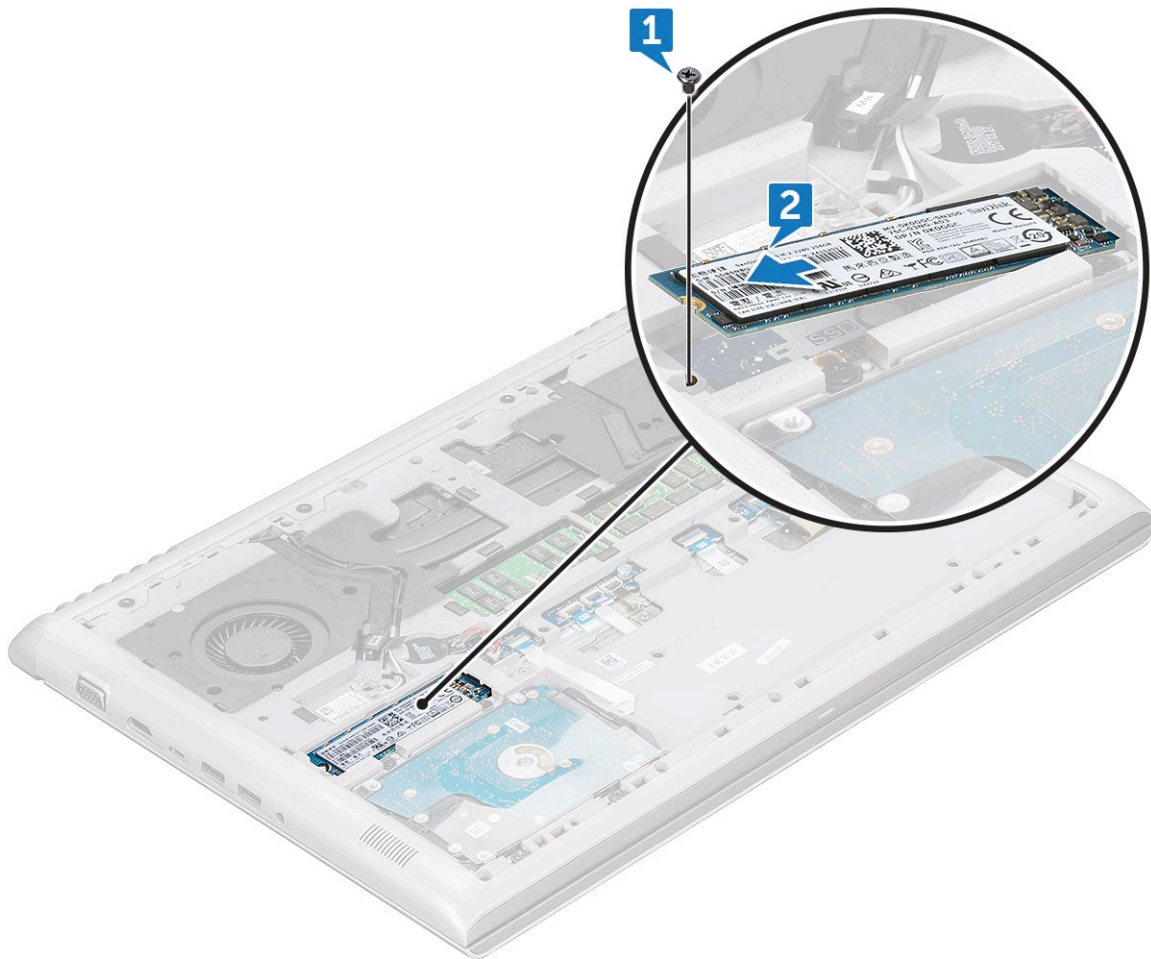

## Installing the M.2 Solid State Drive — SSD

- 1 Insert the SSD into the connector on the computer.
- 2 Replace the M3x3L screw to secure the SSD to the computer.
- 3 Install the:
  - a battery
  - b base cover
- 4 Follow the procedure in [After working inside your computer](#).

## WLAN card

### Removing the WLAN card

- 1 Follow the procedure in [Before working inside your computer](#).
- 2 Remove the:
  - a base cover
  - b battery
- 3 To remove the WLAN card:
  - a Remove the M2x3L screw that secures the WLAN card to the computer [1].
  - b Remove the tab that secures the WLAN cables [2].

- c Disconnect the WLAN cables from the connectors on the WLAN card [3].
- d Lift the WLAN card away from the connector [4].

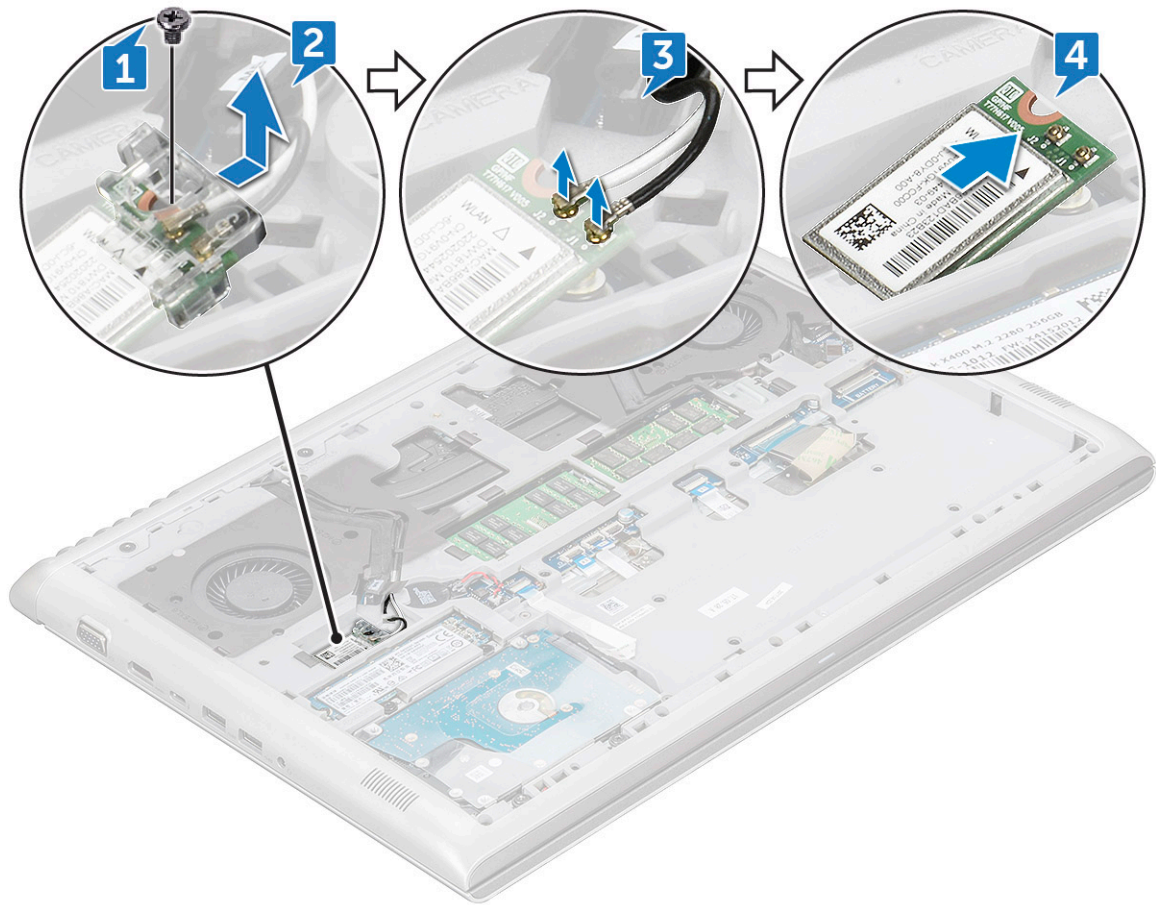

## Installing the WLAN card

- 1 Insert the WLAN card into the slot on the computer.
- 2 Connect the WLAN cables to the connectors on the WLAN Card.
- 3 Place the bracket and replace the M2x3L screw to secure it to the computer.
- 4 Install the:
  - a battery
  - b base cover
- 5 Follow the procedure in [After working inside your computer](#).

## Rear cover

### Removing the rear cover

- 1 Follow the procedure in [Before working inside your computer](#).
- 2 Remove the:
  - a base cover
  - b battery
- 3 To remove the screws:
  - a Remove the M2x2L(OD7) screws that secure the rear cover to the computer [1].



b Pry the rear cover from the edge [2].

**NOTE:** You may need a plastic scribe to pry the rear cover from the edge.

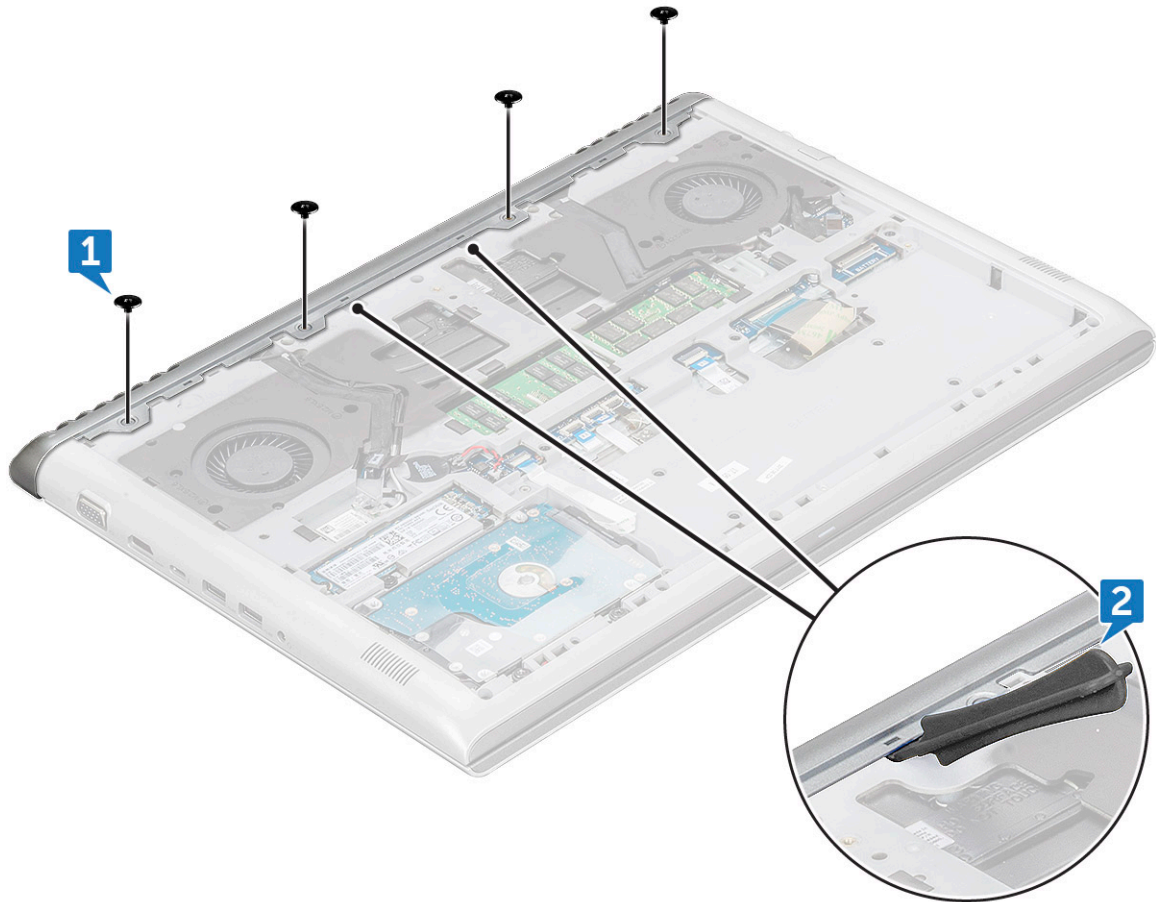

4 Pry the edges of the rear cover using a plastic scribe.

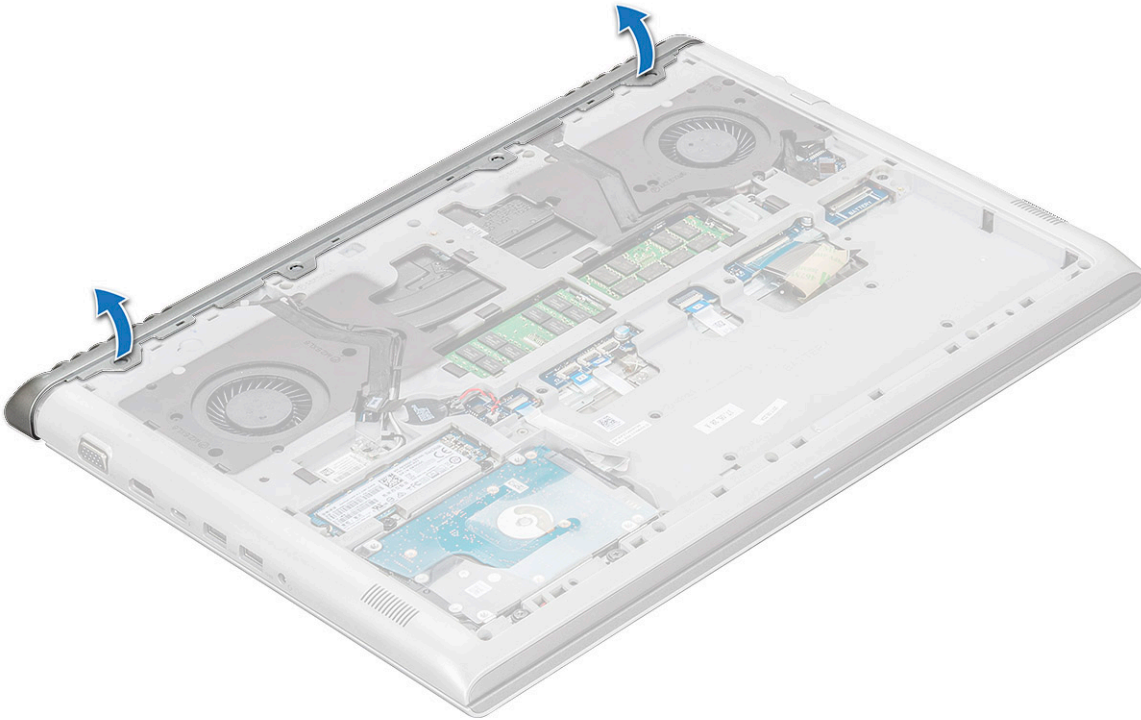

- 5 Remove the rear cover from the computer.

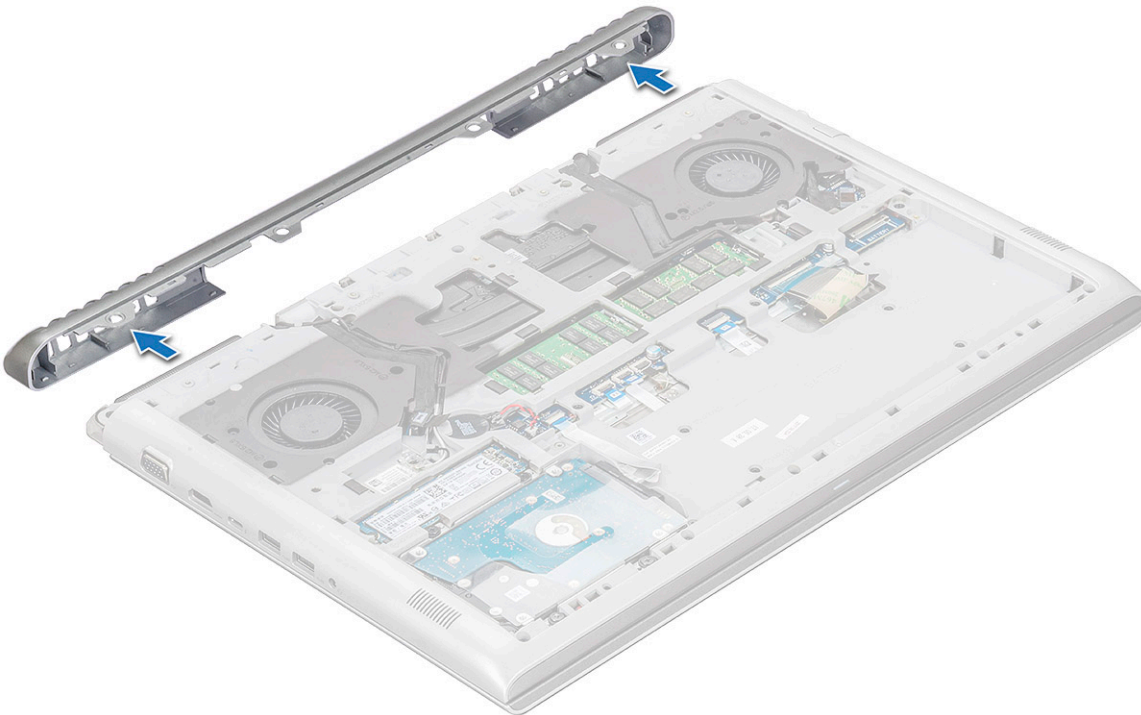

## Installing the rear cover

- 1 Press the edges of the rear cover until it clicks into place.
- 2 Tighten the M2x2L(OD7) screws to secure the rear cover to the computer.



- 3 Install the:
  - a battery
  - b base cover
- 4 Follow the procedure in [After working inside your computer](#).

## Back cover

### Removing the back cover

- 1 Follow the procedure in [Before working inside your computer](#).
- 2 Remove the:
  - a base cover
  - b battery
- 3 To disconnect the cables:
  - a Disconnect the camera cable and unroute from the routing channel [1, 2].
  - b Disconnect the WLAN cable and unroute from the routing channel [3, 4].

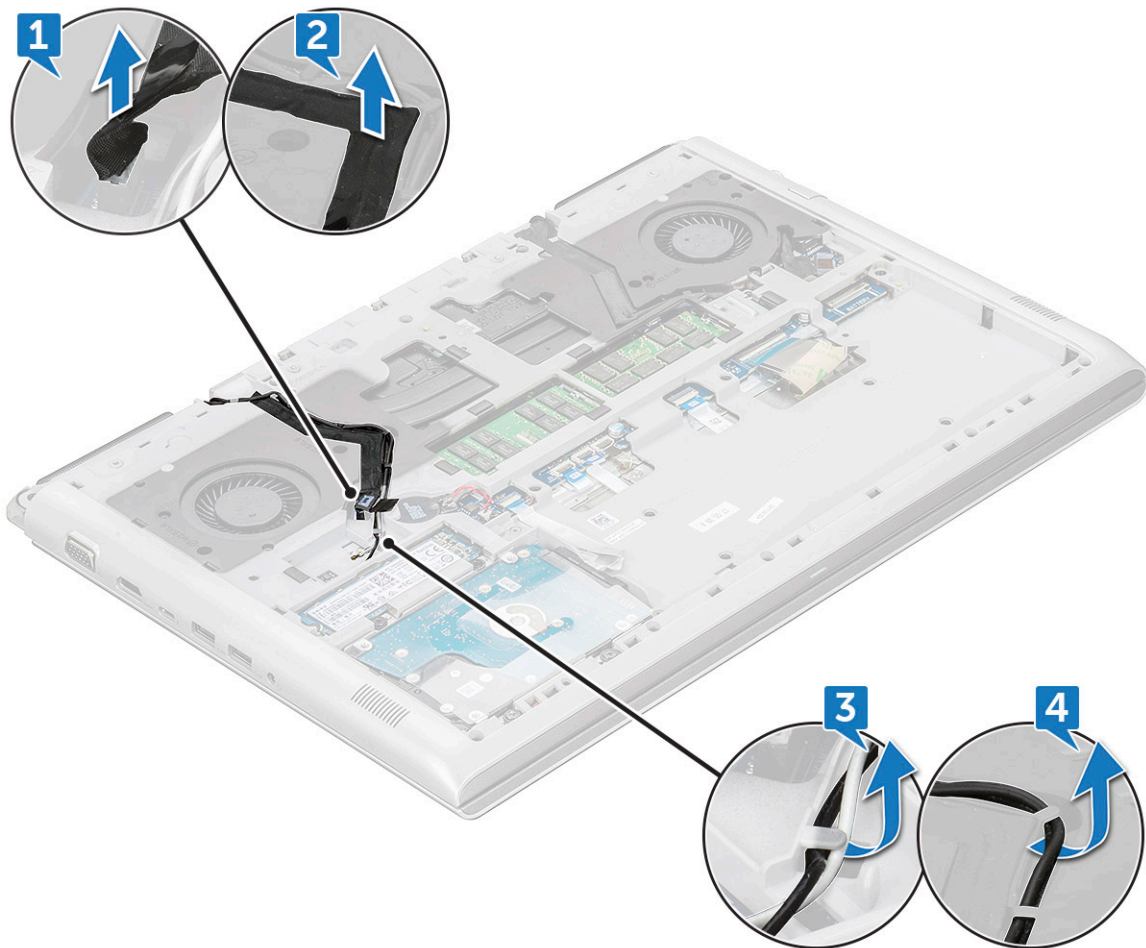

- 4 Disconnect the eDP cable:
  - a Remove the screw (M2x3) that secures the eDP bracket to the computer [1].
  - b Lift the metal tab from the computer [2].
  - c Disconnect the eDP cable from the computer [3].
  - d Unroute the eDP cable from the routing channel [4].

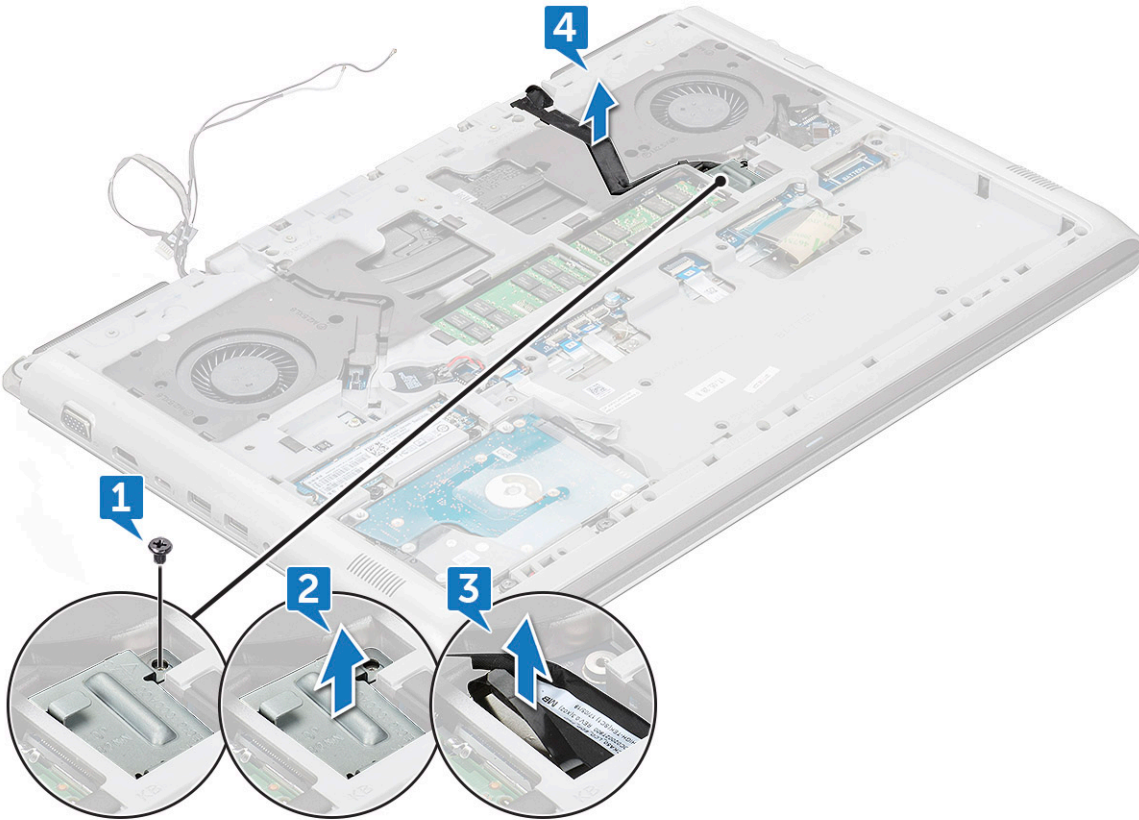

- 5 Disconnect the following cables:
- a Disconnect the Power, LED and Keyboard backlight cable from the connector [1].
  - b Disconnect the touchpad cable from the connector [2].
  - c Remove the white adhesive tape and disconnect the keyboard cable from the connector [3, 4].

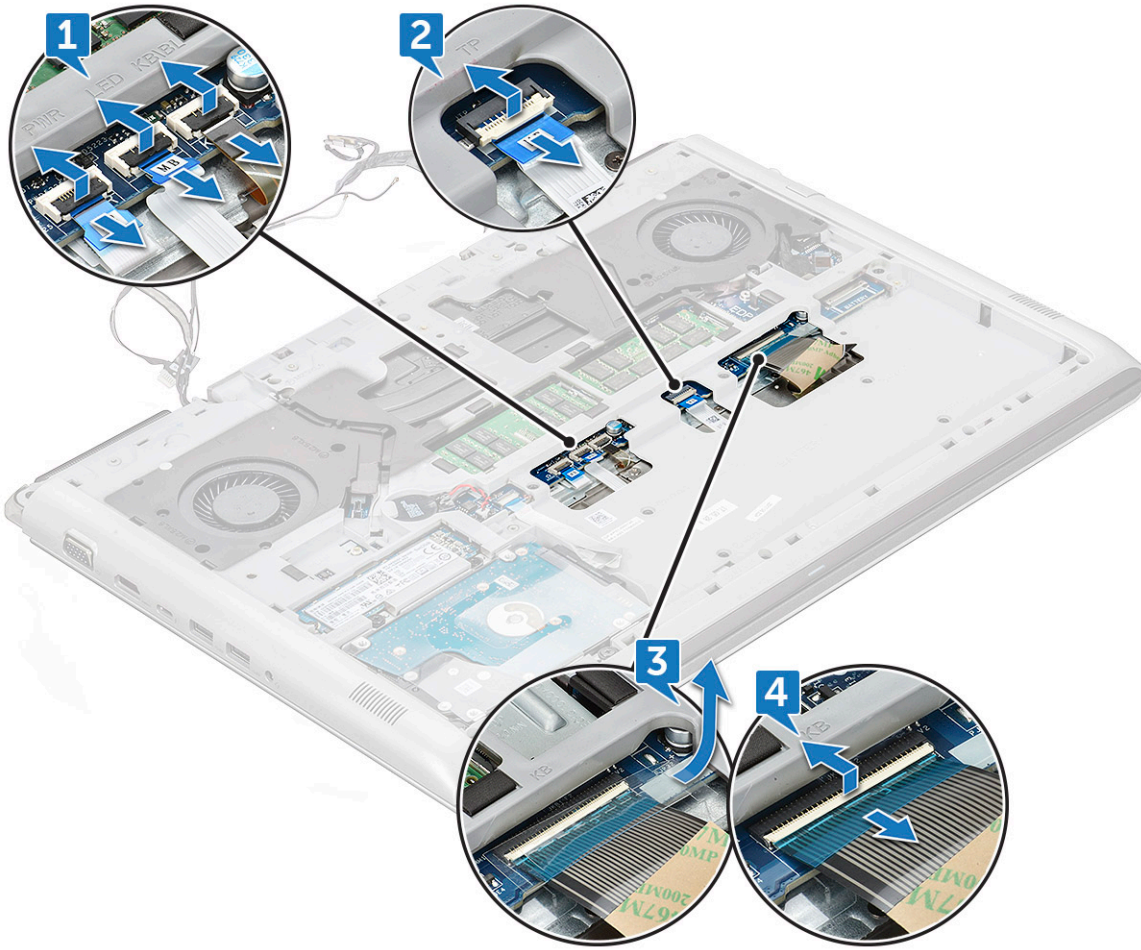

6 Remove the M2.5xL6 (19) screws that secure the back cover to the computer.

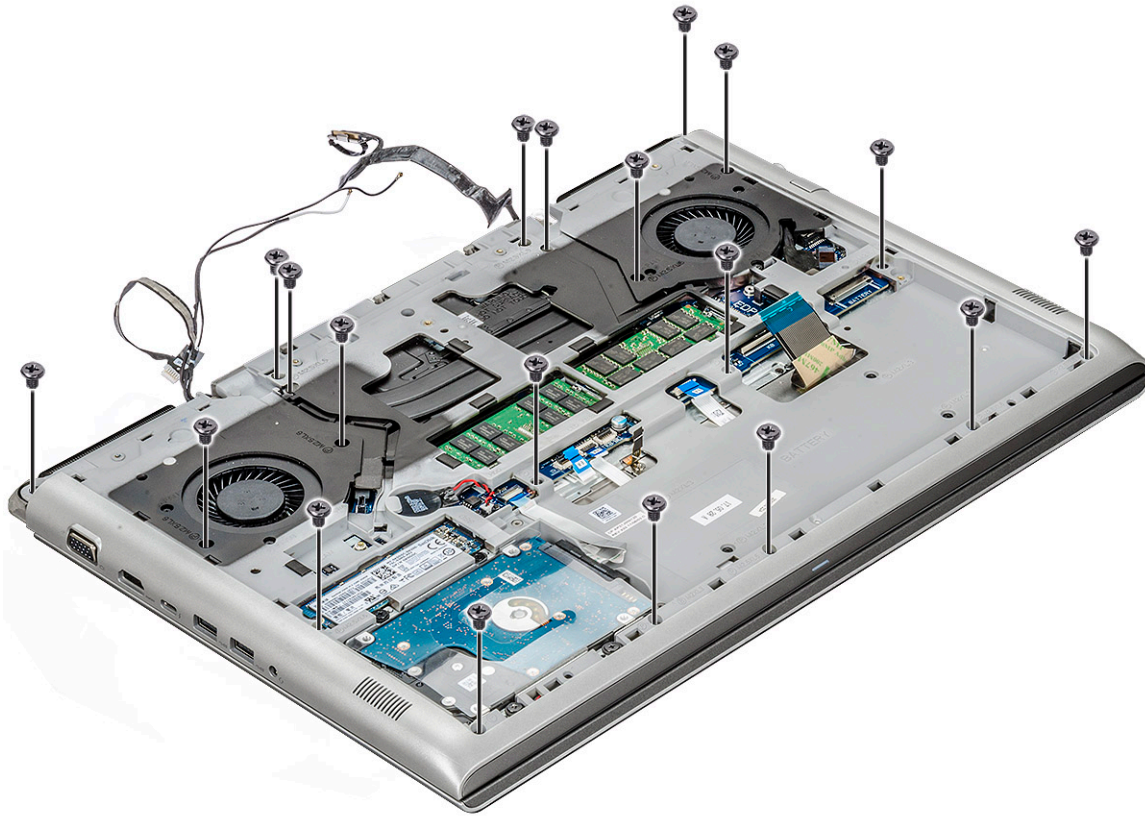

7 Remove the M2L3(4) screws and turn over the system [1, 2].

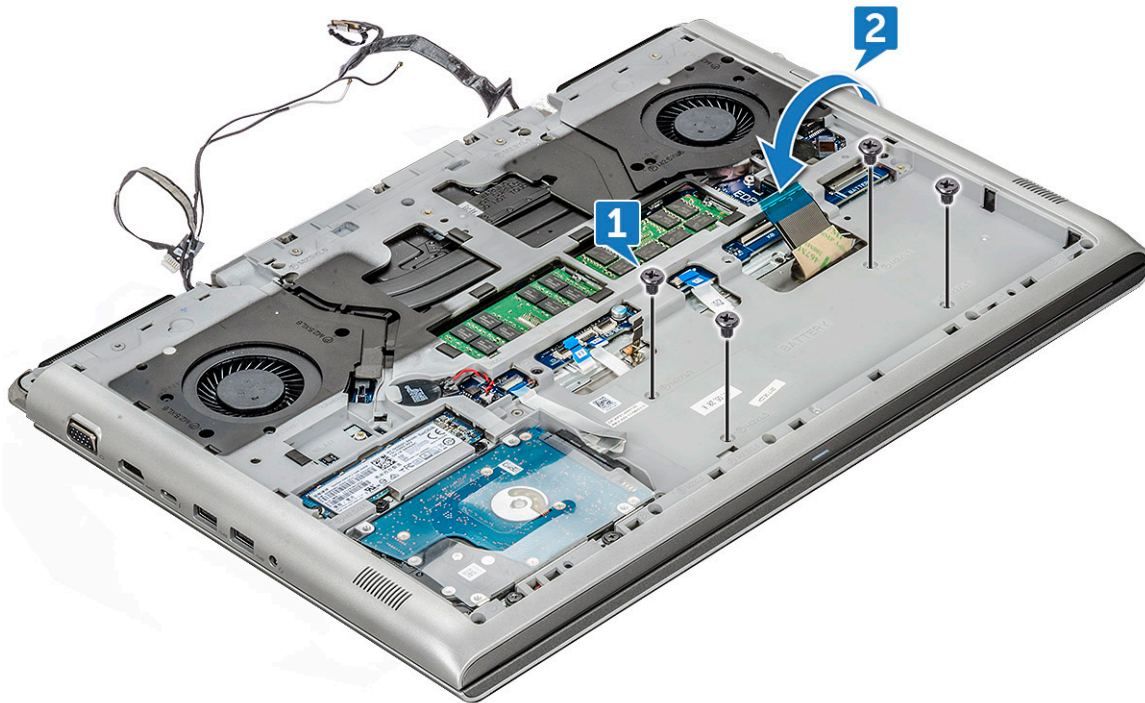

8 Open the display assembly at 90° angle.



- 9 To remove the back cover:
  - a Using a plastic scribe, pry the edges of the palmrest [1, 2].
  - b Lift the palmrest away from the back cover [3].

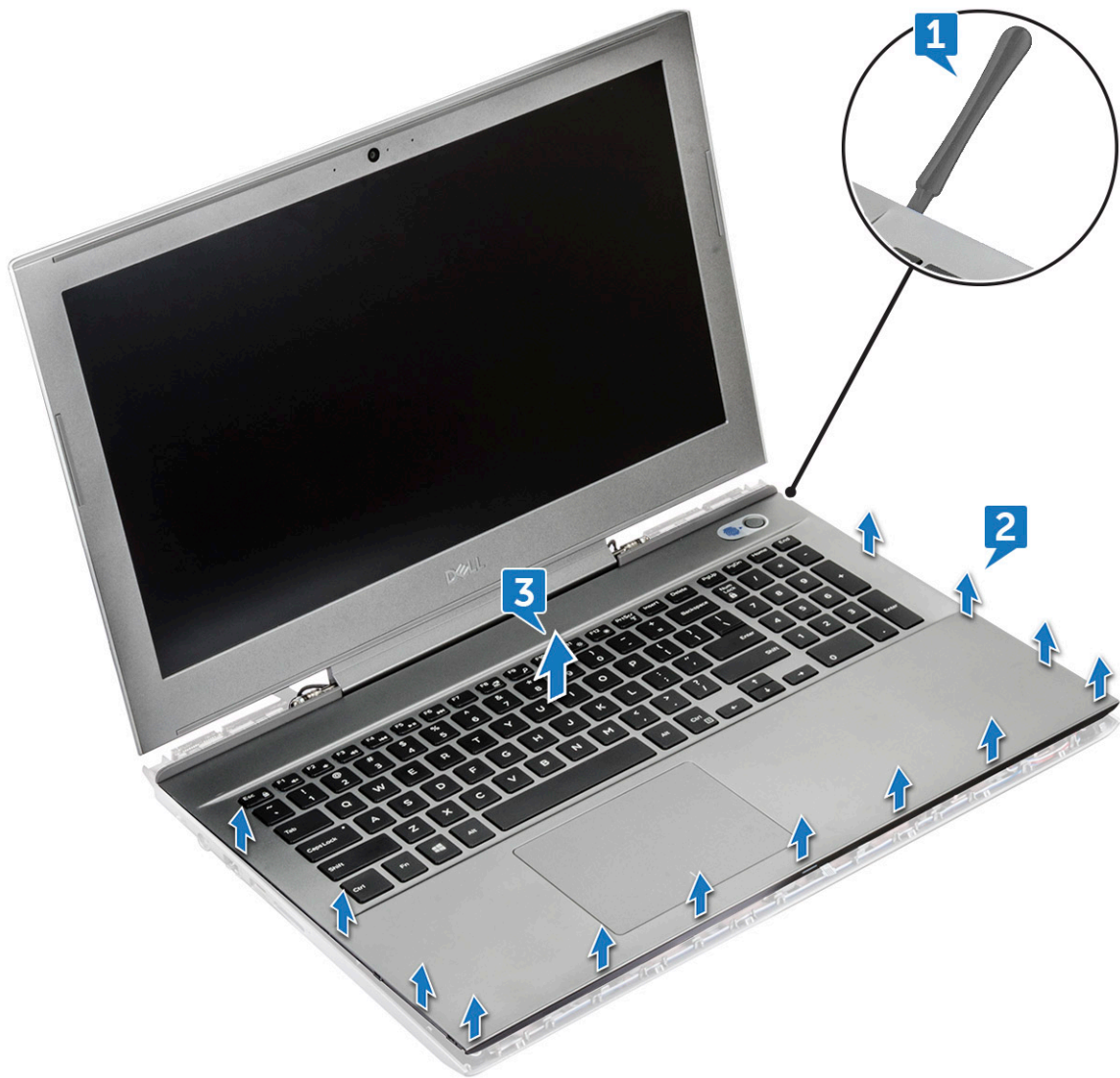

10 The component you are left with is the back cover.

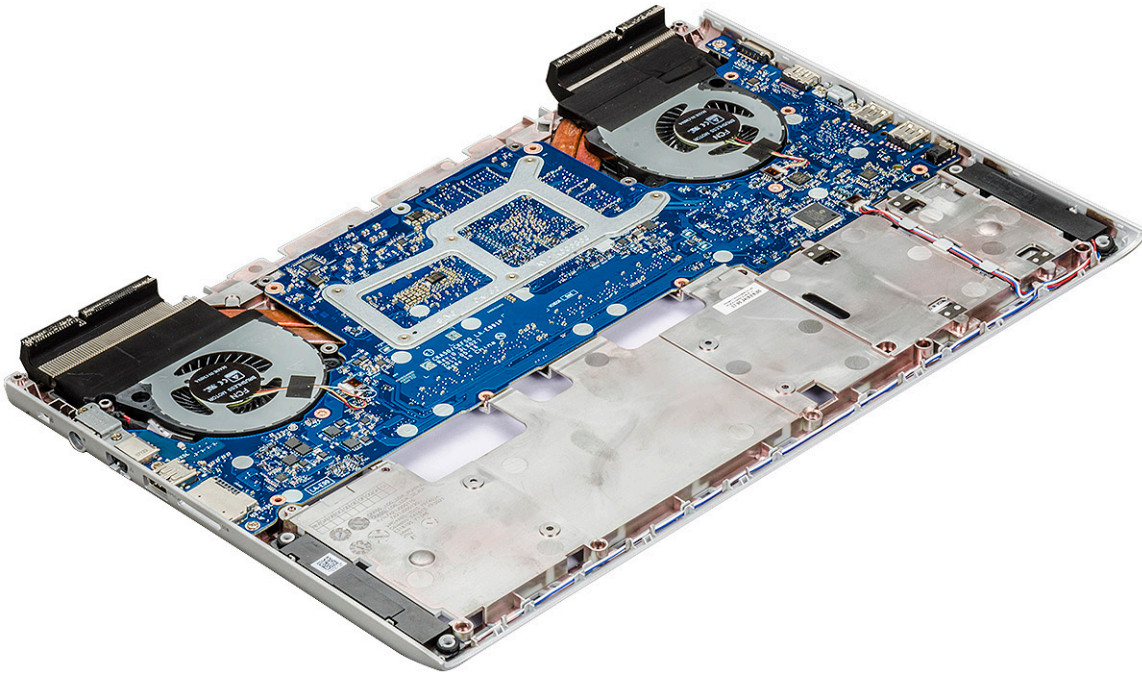

## Installing the back cover

- 1 Press the edges of the back cover until it clicks into place.
- 2 Close the display assembly and turn over the system.
- 3 Replace the M2L3(4) and M2.5xL6 (19) screws to the back cover to the computer.
- 4 Connect the power, LED and Keyboard backlight cable, touchpad, keyboard cable and affix the white adhesive tape to the connector to the computer.
- 5 Route the eDP cable through the routing and connect the cable to the computer.
- 6 Place the metal bracket and replace the M2x3 screw to secure the eDP to the computer.
- 7 Route the camera and WLAN cables through the routing channel and connect the cable to the computer.
- 8 Install the:
  - a [battery](#)
  - b [base cover](#)
- 9 Follow the procedure in [After working inside your computer](#).

## Speaker

### Removing the speaker

- 1 Follow the procedure in [Before working inside your computer](#).
- 2 Remove the:
  - a [base cover](#)
  - b [battery](#)
  - c [SSD card](#)
  - d [memory module](#)
  - e [rear cover](#)
  - f [back cover](#)

- 3 To remove the speaker:
- a Disconnect the speaker cable [1].
  - b Unroute the cable from routing channel [2, 3, 4].

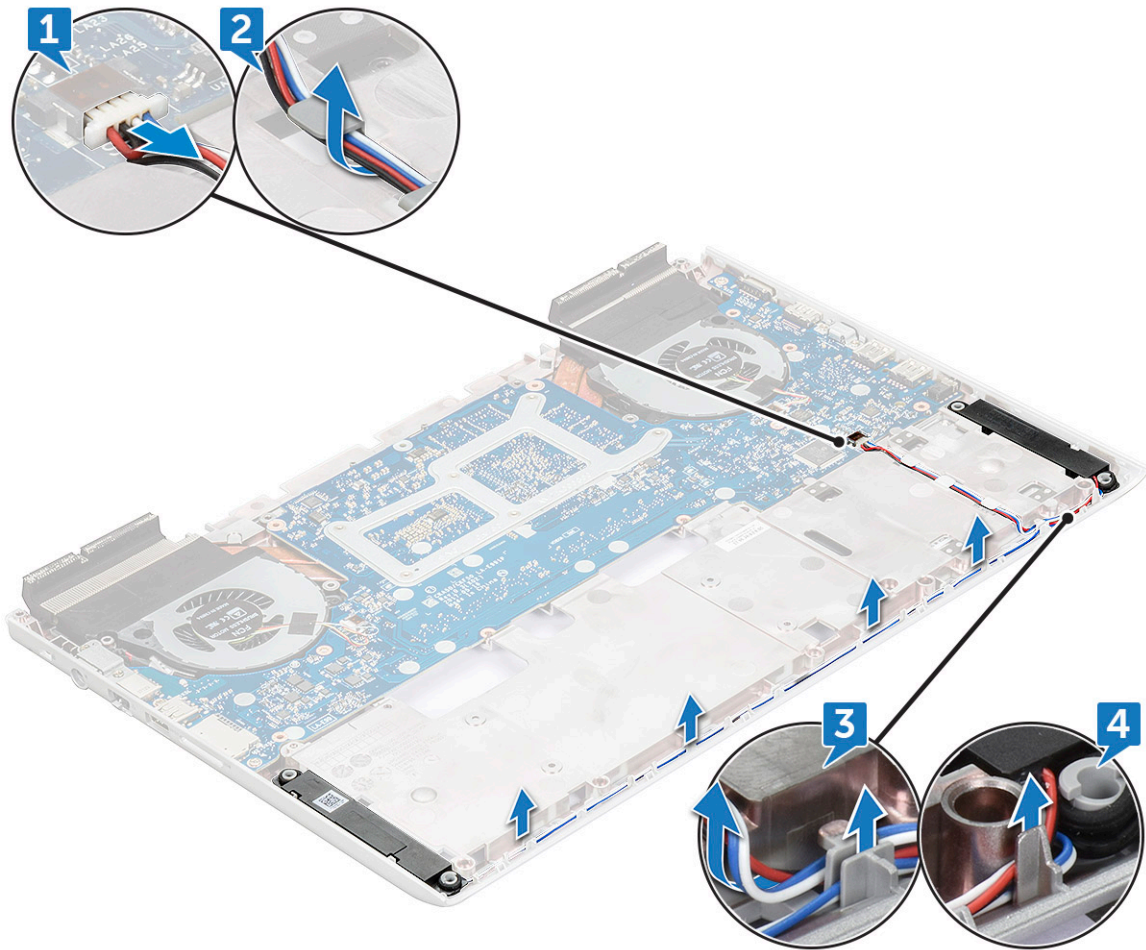

- 4 Lift the speakers, along with the speaker cable, and remove it away from the back cover.

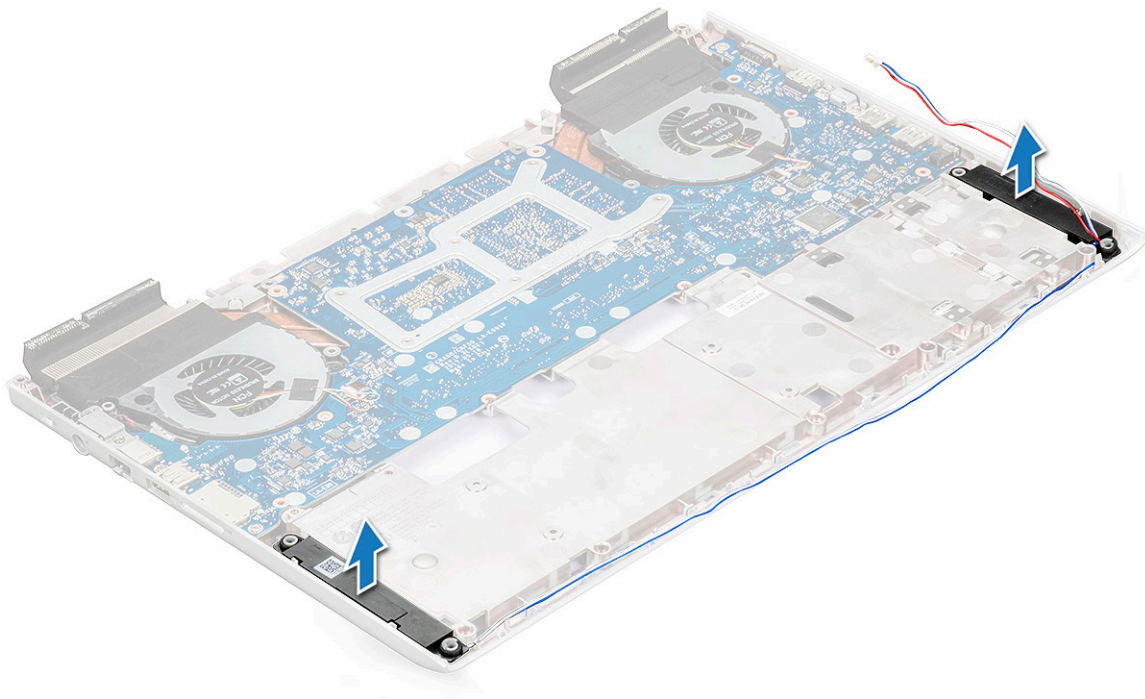

## Installing the speaker

- 1 Align the speakers along the slots on the computer.
- 2 Route the speaker cable through the routing tabs on the computer.
- 3 Connect the speaker cable to the system board.
- 4 Install the:
  - a back cover
  - b rear cover
  - c memory module
  - d SSD card
  - e battery
  - f base cover
- 5 Follow the procedure in [After working inside your computer](#).

## System board

### Removing the system board

- 1 Follow the procedure in [Before working inside your computer](#).
- 2 Remove the:
  - a base cover
  - b battery
  - c SSD card
  - d memory module
  - e rear cover
  - f back cover
- 3 Disconnect the following cable:

- a Disconnect the coin cell battery cable from the connector [1].
- b Disconnect the hard drive cable from the connector [2].

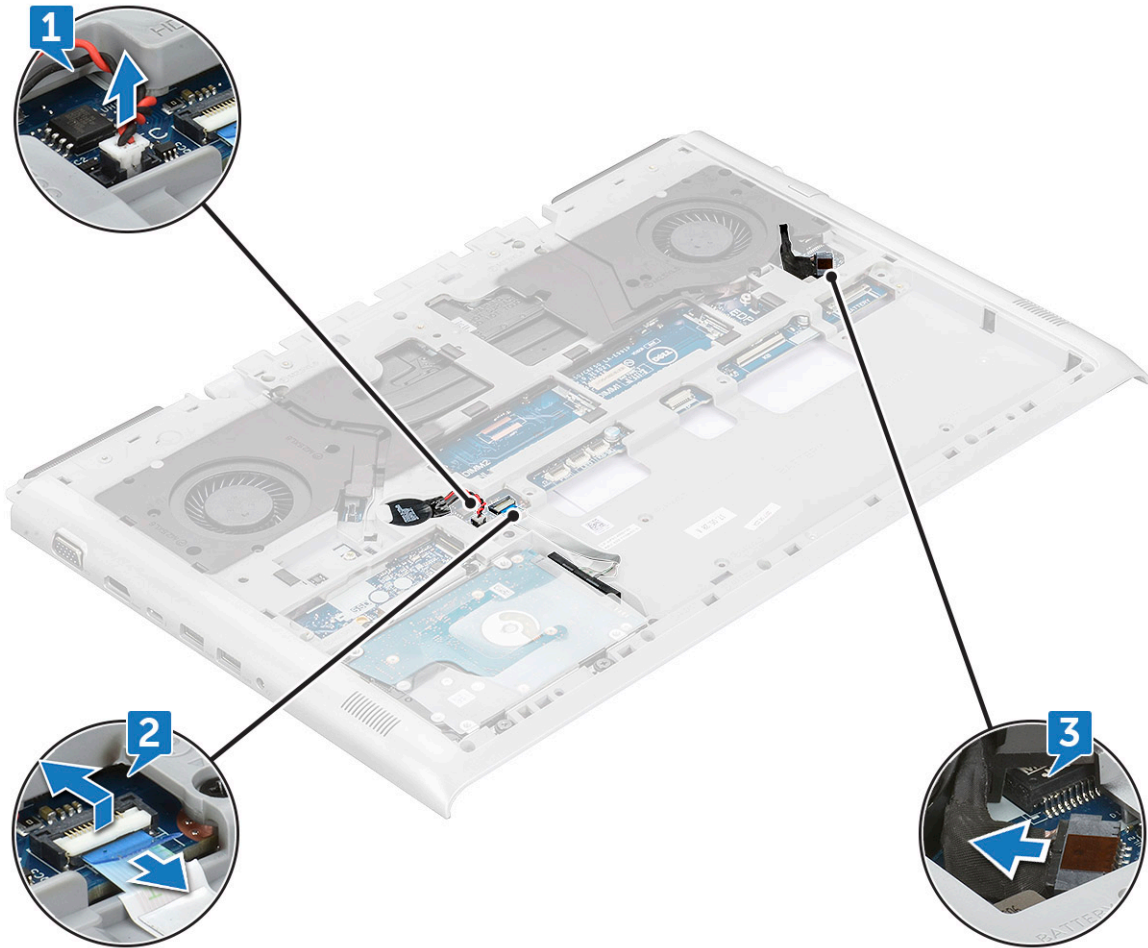

- 4 Remove the following metal tab:
  - a Remove the M2.5xL5(2) screws that secure the metal tab on the system board [1].
  - b Lift the metal tab that secures the power port on the system board [2].
  - c Remove the M2.5xL5(2) screws that secure the metal tab on the system board [3].
  - d Lift the metal tab that secures the Thunderbolt port on the system board [4].
  - e Disconnect the speaker cable from the system board [5].

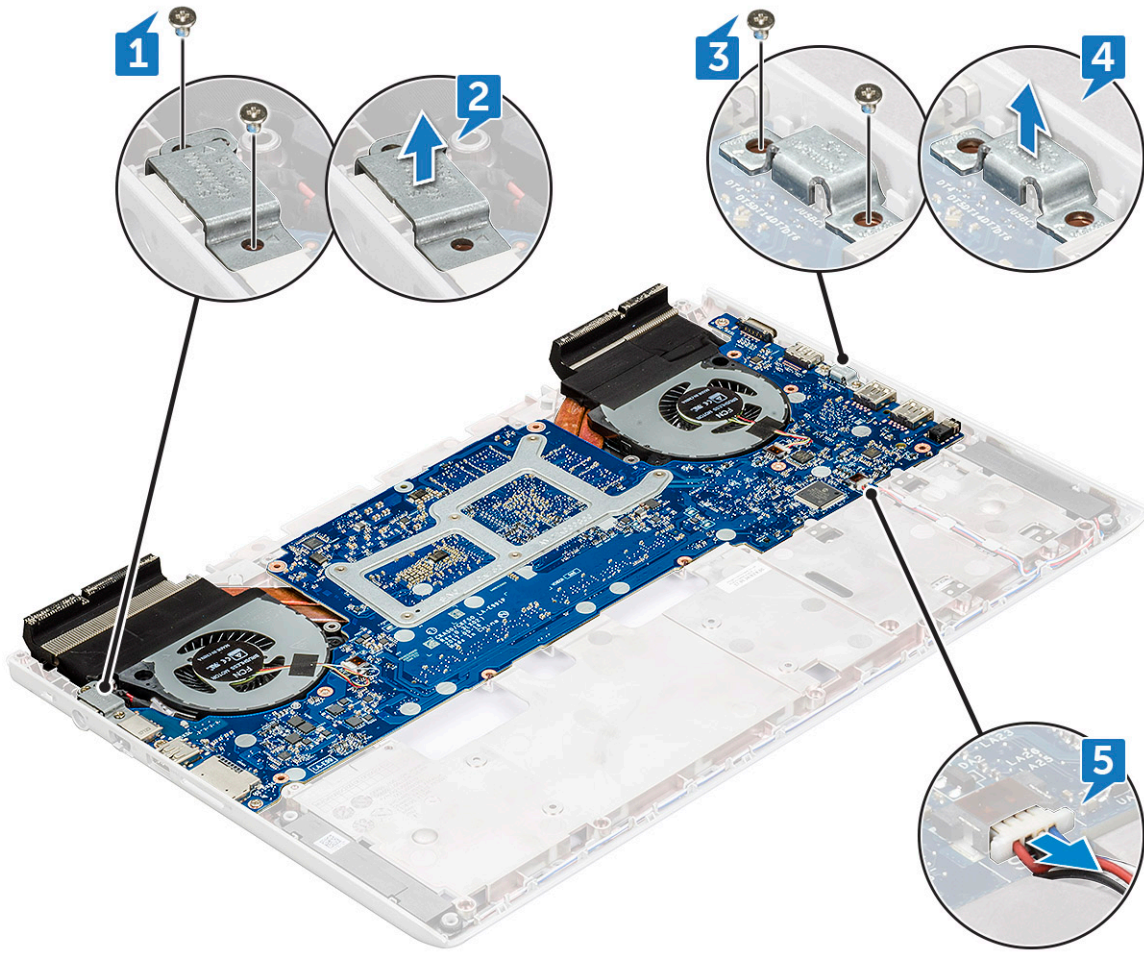

5 Remove the M2x3L(4) screws that secure the system fan to the system board.

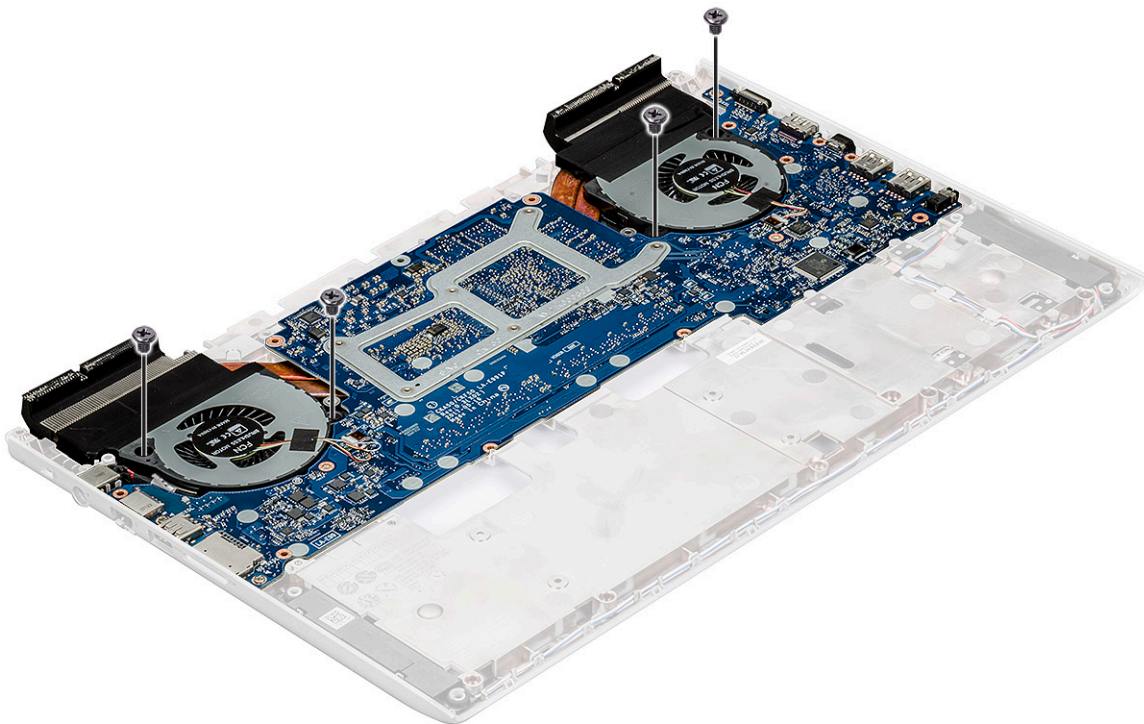

- 6 To remove the system board:
  - a Remove the 2.5x5L(3) screws that secure the system board to the computer [1].
  - b Lift and remove the system board from the computer [2].

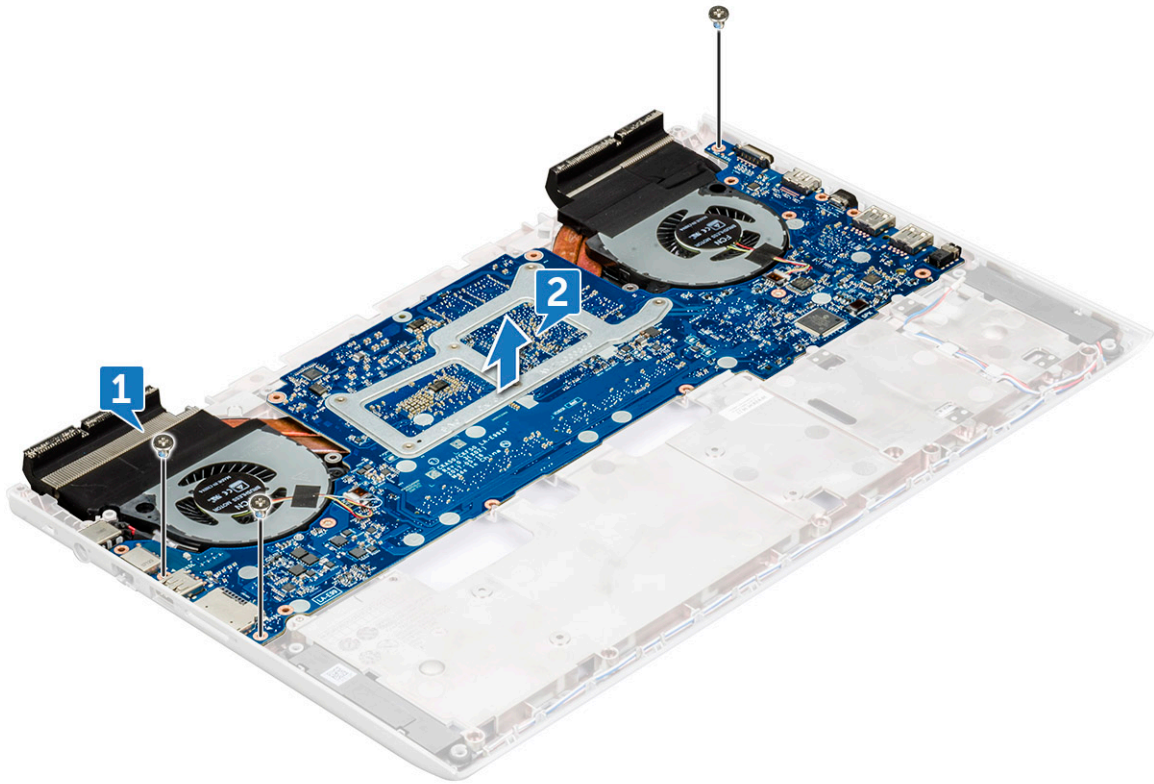

## Installing the system board

- 1 Align the system board into its original position on the computer.
- 2 Replace the 2.5x5L (3) screws to secure the system board to the computer.
- 3 Replace the M2x3L(4) screws that secure the system fan to the system board.
- 4 Connect the speaker cable to the system board.
- 5 Place the metal on the Thunderbolt port and replace M2.5xL5(2) screws that secures on the system board.
- 6 Place the metal on the power port and replace M2.5xL5(2) screw that secures on the system board.
- 7 Connect the coin cell battery and hard drive cable to the connector on the system board.
- 8 Connect the speaker cable to the system board.
- 9 Install the:
  - a [back cover](#)
  - b [rear cover](#)
  - c [memory module](#)
  - d [SSD card](#)
  - e [battery](#)
  - f [base cover](#)
- 10 Follow the procedure in [After working inside your computer](#).



# Power connector port

## Removing the power connector port

- 1 Follow the procedure in [Before working inside your computer](#).
- 2 Remove the:
  - a [base cover](#)
  - b [battery](#)
  - c [SSD card](#)
  - d [memory module](#)
  - e [rear cover](#)
  - f [back cover](#)
  - g [system board](#)
- 3 To remove power connector port:
  - a Unroute the power connector port from the routing channel [1].
  - b Remove the power connector port from the computer [2].



# Installing the power connector port

- 1 Place the power connector port on the computer.
- 2 Route the power connector port cable through the routing channels on the computer.
- 3 Install the:
  - a system board
  - b back cover
  - c rear cover
  - d memory module
  - e SSD card
  - f battery
  - g base cover
- 4 Follow the procedure in [After working inside your computer](#).

## Heat sink

### Removing the heat sink assembly

- 1 Follow the procedure in [Before working inside your computer](#).
- 2 Remove the:
  - a base cover
  - b battery
  - c SSD card
  - d memory module
  - e rear cover
  - f back cover
- 3 Disconnect the heat sink assembly cables from the system board [1, 2].

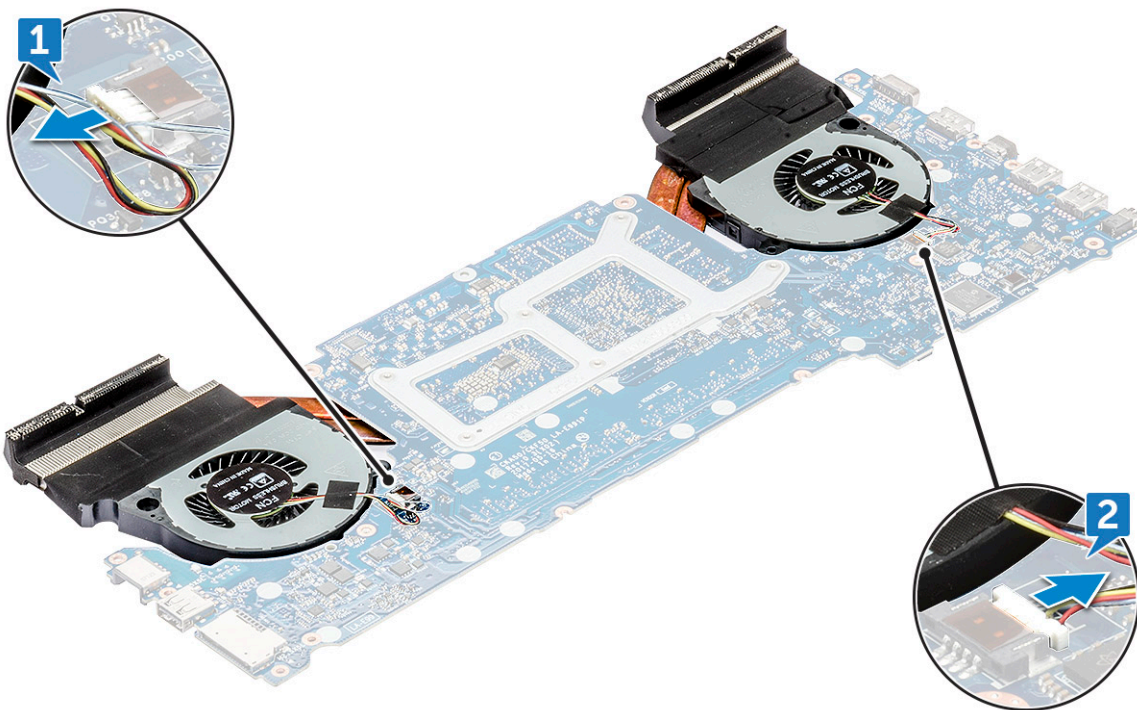

- 4 To remove the heat sink assembly:
  - a Turn over the system board and remove the M2x3L(6) screws that secure the heat sink assembly to the system board [1].

**NOTE:** Loosen the screws based on the numbering on the heat sink.

- b Lift the heat sink assembly from the system board [2].

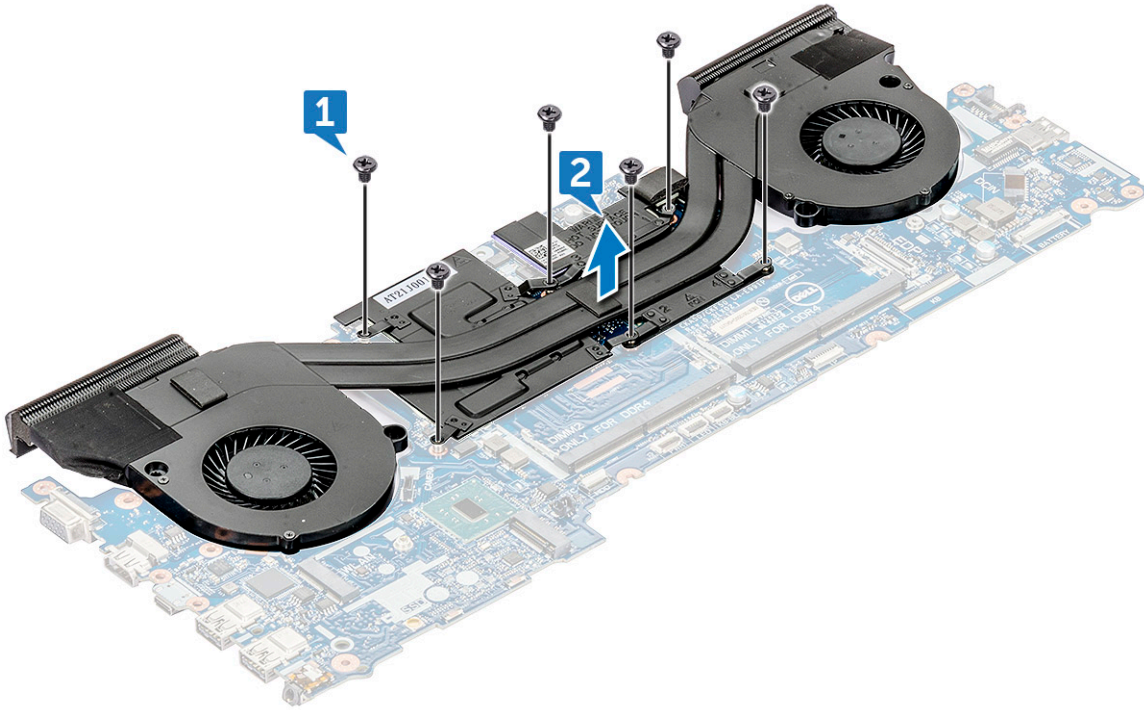

- 5 The component you are left with is the heat sink assembly.

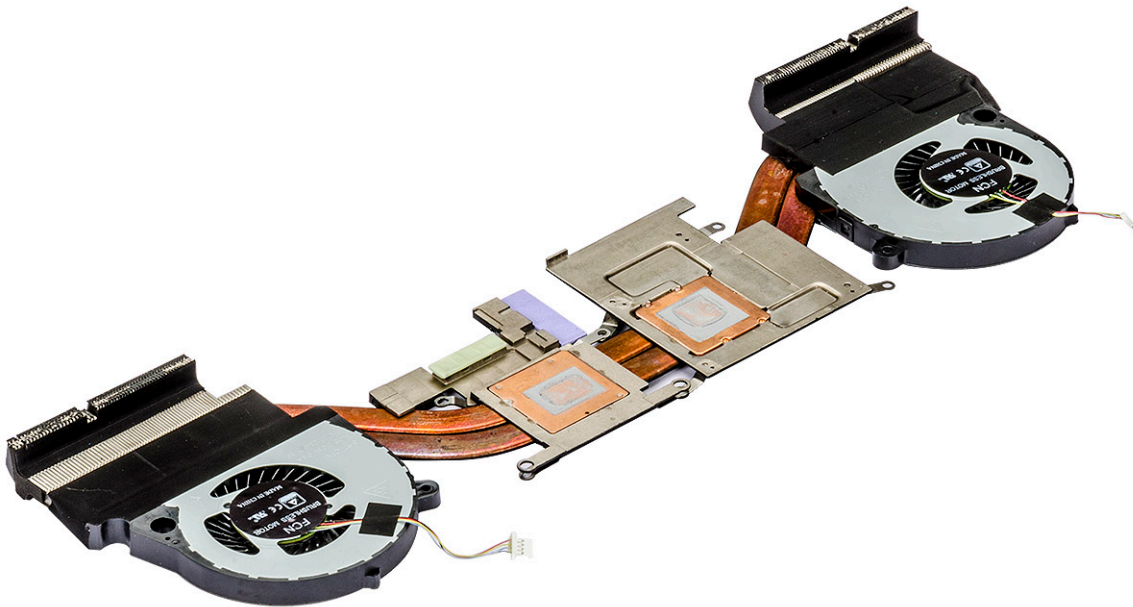

## Installing the heat sink assembly

- 1 Replace the heat sink assembly on the system board.
- 2 Replace the M2x3L(6) screws to secure the heat-sink assembly to the system board.

**NOTE:** Tighten the screws based on the order mentioned in the removal procedure.

- 3 Turn over the system board.
- 4 Connect the heat sink assembly cable to the system board.
- 5 Install the:
  - a back cover
  - b rear cover
  - c memory module
  - d SSD card
  - e battery
  - f base cover
- 6 Follow the procedure in [After working inside your computer](#).

## Touchpad

### Removing the touchpad

- 1 Follow the procedure in [Before working inside your computer](#).
- 2 Remove the:
  - a base cover
  - b battery
  - c SSD card
  - d memory module
  - e rear cover
  - f back cover
- 3 Remove the M2x2L (4) screws from the touchpad board and slide from the display assembly [1, 2].

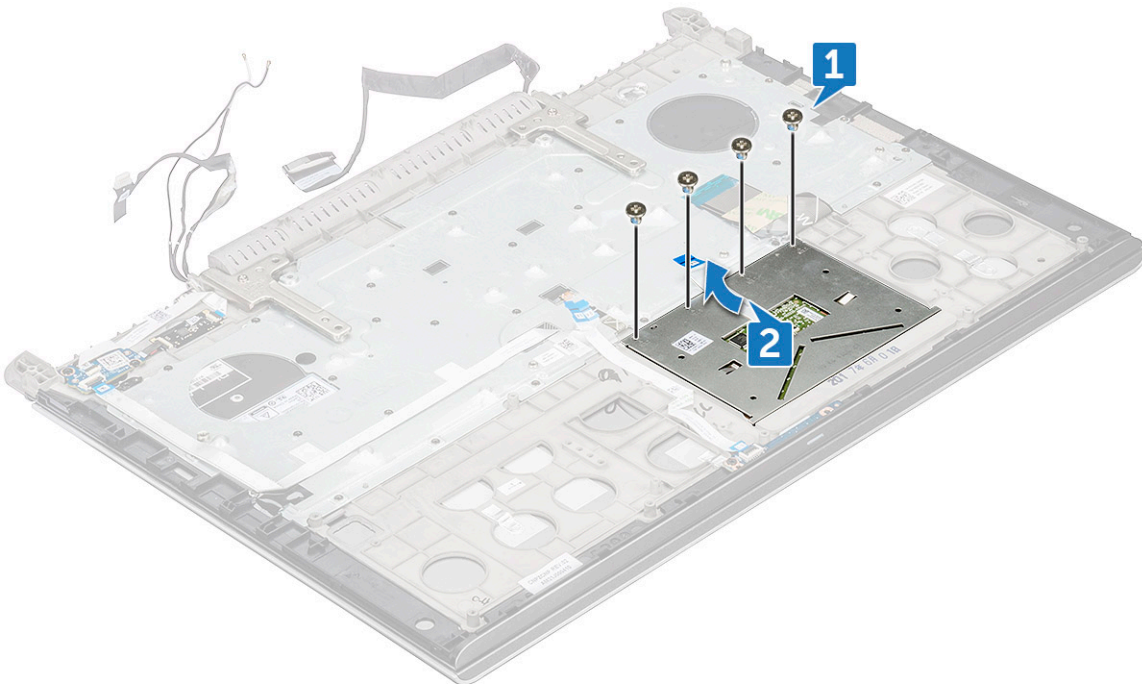

- 4 Lift the touchpad from the display assembly.



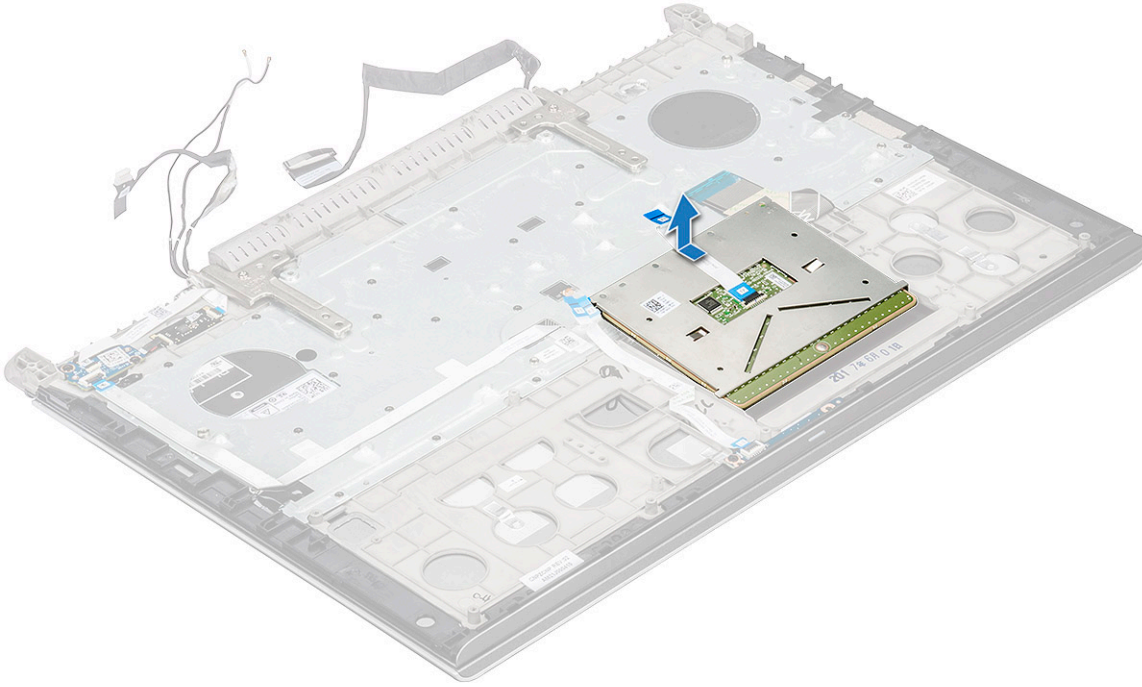

## Installing the touchpad

- 1 Place the touchpad into the slots on the display assembly.
- 2 Replace the M2x2L (4) screws that secure touchpad on the display assembly.
- 3 Install the:
  - a back cover
  - b rear cover
  - c memory module
  - d SSD card
  - e battery
  - f base cover
- 4 Follow the procedure in [After working inside your computer](#).

## LED board

### Removing the LED board

- 1 Follow the procedure in [Before working inside your computer](#).
- 2 Remove the:
  - a base cover
  - b battery
  - c SSD card
  - d memory module
  - e rear cover
  - f back cover
- 3 To remove LED board:
  - a Lift the latch and disconnect the LED board cable [1].
  - b Remove M2x3L screw that secures the LED board cable to the display assembly [2].

c Slide and lift the LED board from the display assembly [3].

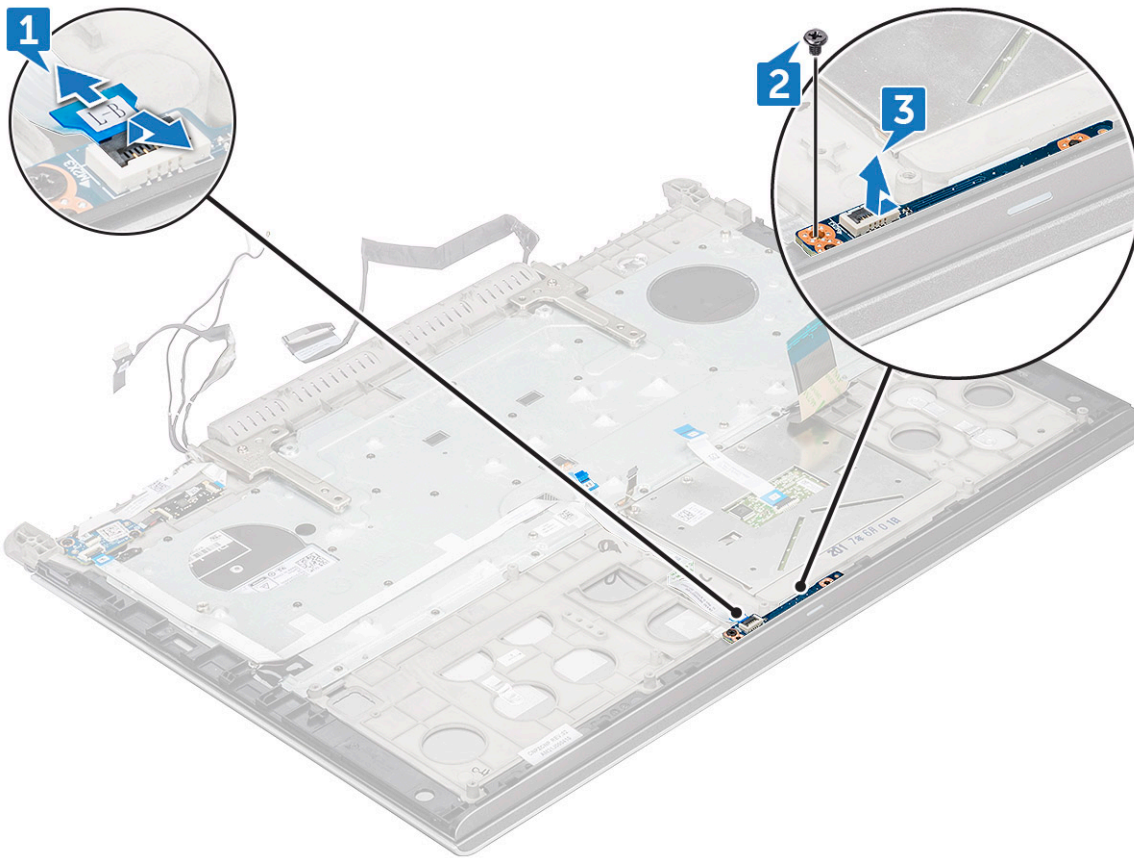

## Installing the LED board

- 1 Place the LED board into the slots on the display assembly.
- 2 Replace the M2x3L screw that secures LED board on the display assembly.
- 3 Connect the LED board cable to the display assembly.
- 4 Install the:
  - a back cover
  - b rear cover
  - c memory module
  - d SSD card
  - e battery
  - f base cover
- 5 Follow the procedure in [After working inside your computer](#).

## Power button board

### Removing the power button board

- 1 Follow the procedure in [Before working inside your computer](#).
- 2 Remove the:
  - a base cover
  - b battery



- c SSD card
- d memory module
- e rear cover
- f back cover

- 3 To release the power button board:
- a Lift the latch and disconnect the power button board cable [1].
  - b Peel of the power button board cable from the adhesive [2].

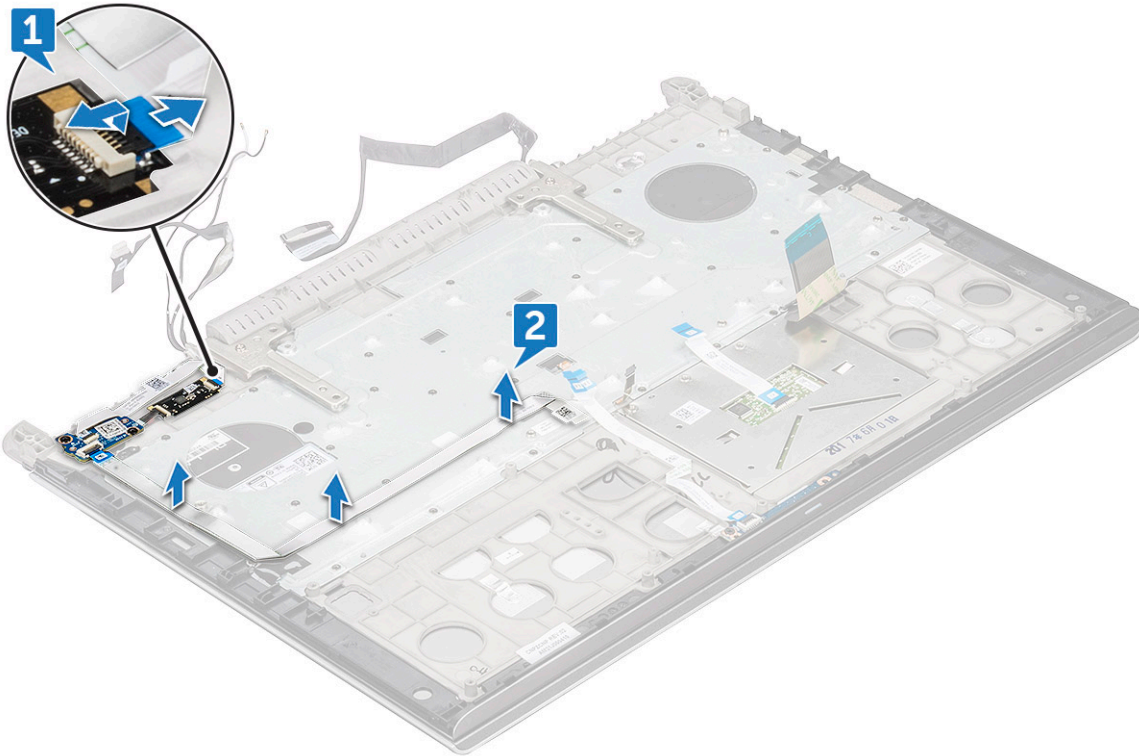

- 4 To remove power button board:
- a Remove the M2x3L (2) screws that secure the power button board [1].
  - b Lift and remove the power button board [2].

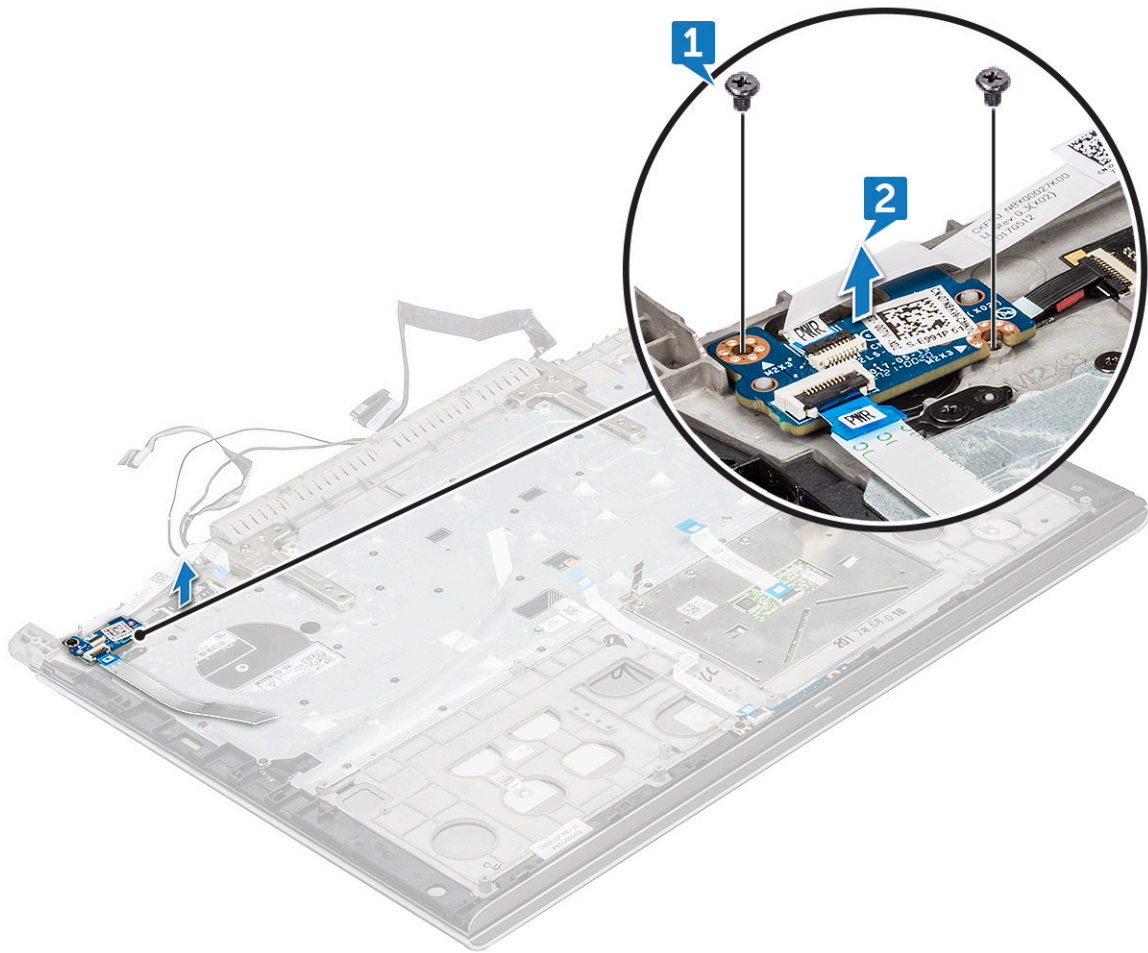

## Installing the power button board

- 1 Place the power button board into the slots on the display assembly.
- 2 Replace the M2x3L (2) screw that secures power button board on the display assembly.
- 3 Connect the power button board cable to the display assembly.
- 4 Install the:
  - a [back cover](#)
  - b [rear cover](#)
  - c [memory module](#)
  - d [SSD card](#)
  - e [battery](#)
  - f [base cover](#)
- 5 Follow the procedure in [After working inside your computer](#).

## Fingerprint reader

### Removing the fingerprint reader

- 1 Follow the procedure in [Before working inside your computer](#).
- 2 Remove the:



- a base cover
- b battery
- c SSD card
- d memory module
- e rear cover
- f back cover

- 3 To release the fingerprint reader:
- a By using a plastic scribe lift the fingerprint reader board [1].
  - b Remove the M2x2 screws that secure the fingerprint reader to the palm rest [2].
  - c Lift the fingerprint reader away from the palm rest [3].

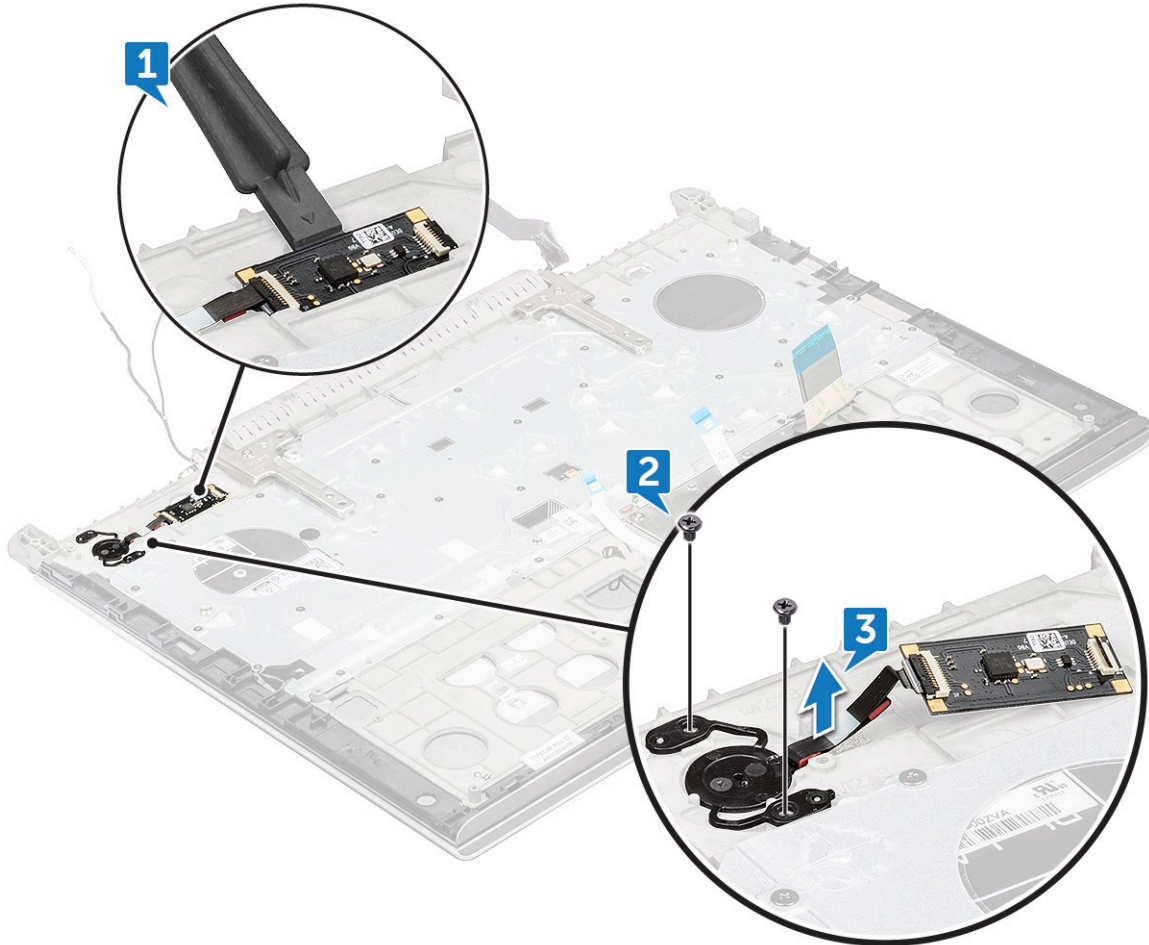

## Installing the fingerprint reader

- 1 Place the fingerprint reader into the slots on the palm rest.
- 2 Replace the M2x2 (2) screws that secure fingerprint reader on the display assembly.
- 3 Install the:
  - a back cover
  - b rear cover
  - c memory module
  - d SSD card
  - e battery
  - f base cover
- 4 Follow the procedure in [After working inside your computer](#).

# Keyboard

## Removing the keyboard

- 1 Follow the procedure in [Before working inside your computer](#).
- 2 Remove the:
  - a base cover
  - b battery
  - c SSD card
  - d memory module
  - e rear cover
  - f back cover
  - g display hinge
- 3 Disconnect the following cables:
  - a power board cable
  - b LED board cable
  - c keyboard backlight cable
  - d touchpad cable
  - e keyboard cable

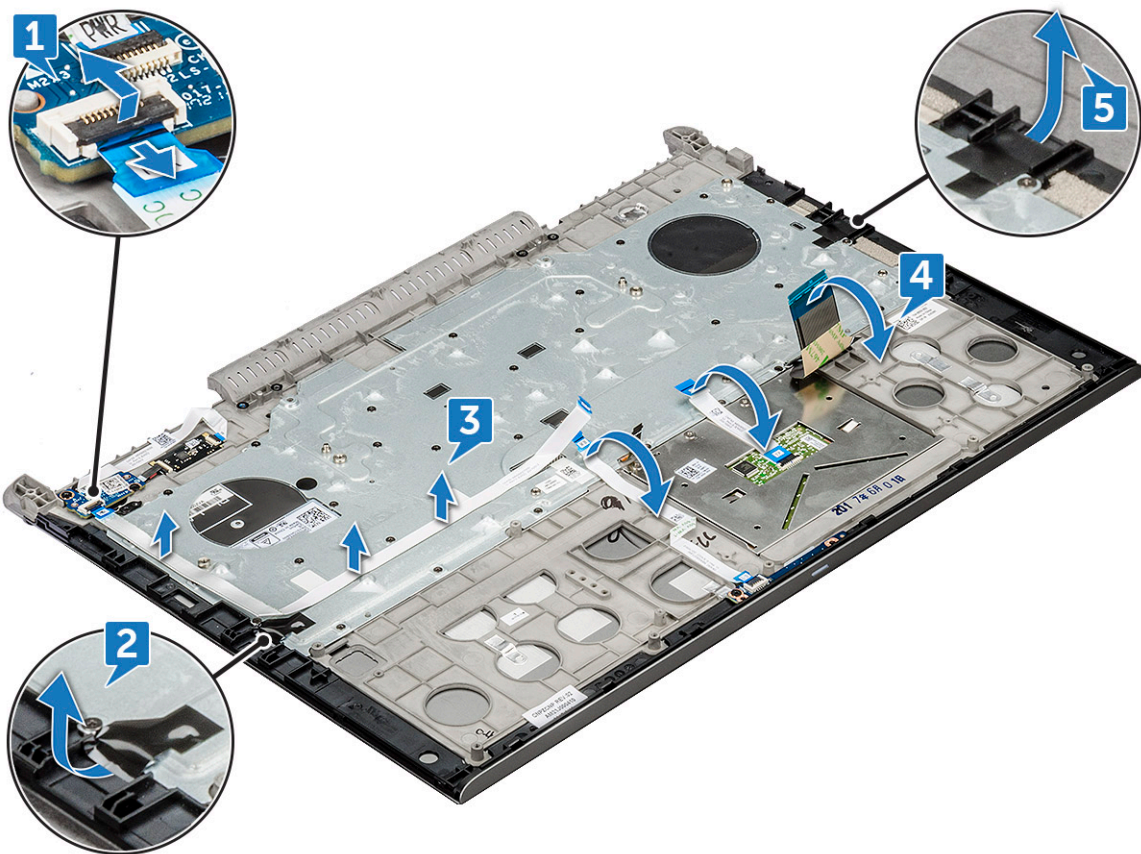

- 4 Remove the M1.6x2.2L (30) screws and lift the keyboard [1, 2].

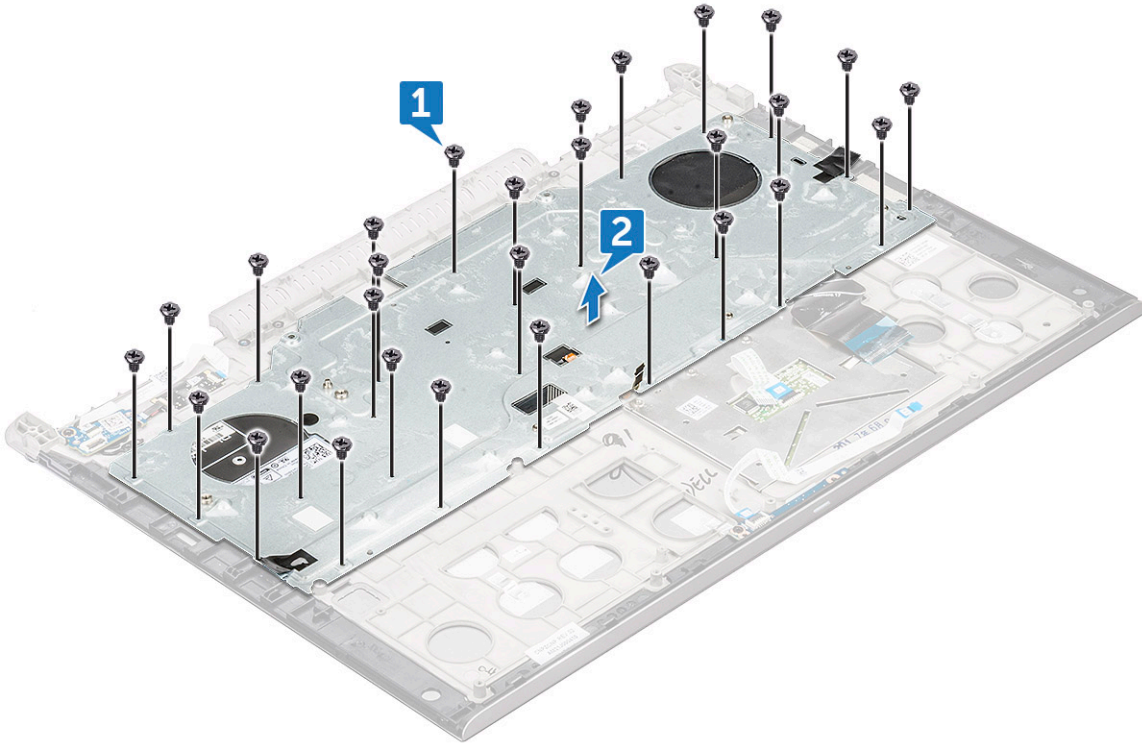

- 5 Remove the keyboard from the palm rest.

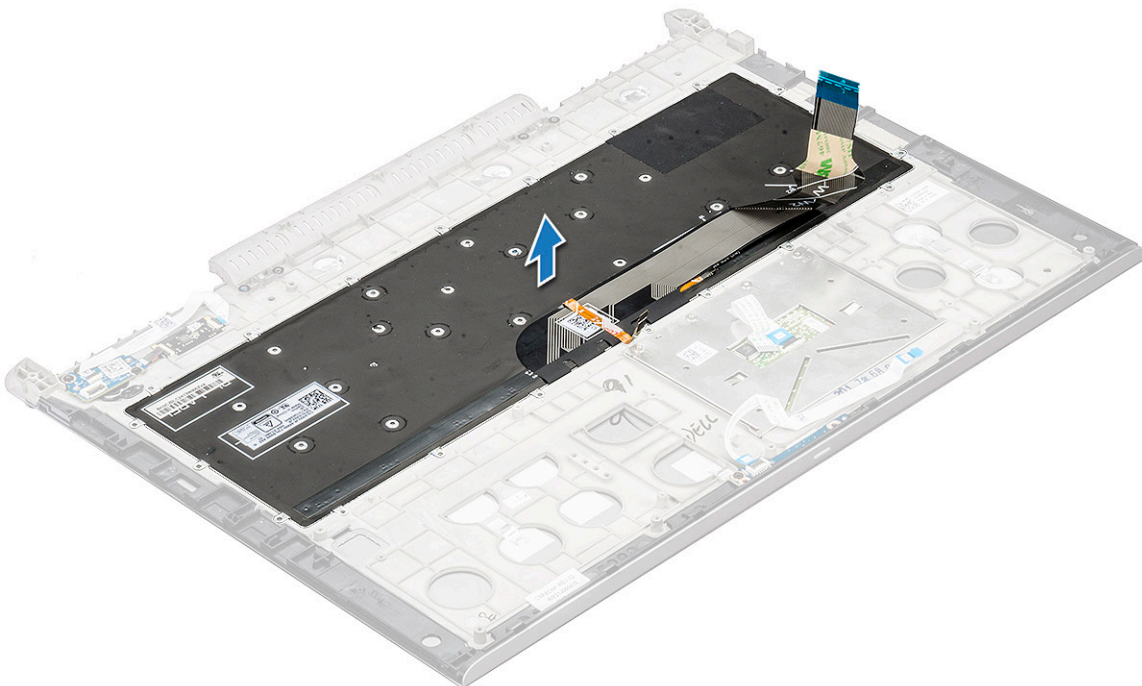

## Installing the keyboard

- 1 Place the keyboard into the slots on the palm rest.
- 2 Replace the M1.6x2.2L (30) screws that secure keyboard on the palm rest.
- 3 Connect the following cable to the display assembly.
  - a power board cable

- b LED board cable
  - c keyboard backlight cable
  - d touchpad cable
  - e keyboard cable
- 4 Install the:
- a display hinge
  - b back cover
  - c rear cover
  - d memory module
  - e SSD card
  - f battery
  - g base cover
- 5 Follow the procedure in [After working inside your computer](#).

## Display assembly

### Removing the display assembly

- 1 Follow the procedure in [Before working inside your computer](#).
- 2 Remove the:
- a base cover
  - b battery
  - c SSD card
  - d memory module
  - e rear cover
  - f back cover
- 3 To remove hinge bracket:
- a Remove M2.5x5L(2) screws that secure the hinge bracket to the display assembly [1].
  - b Lift the hinge bracket from the display assembly [2].

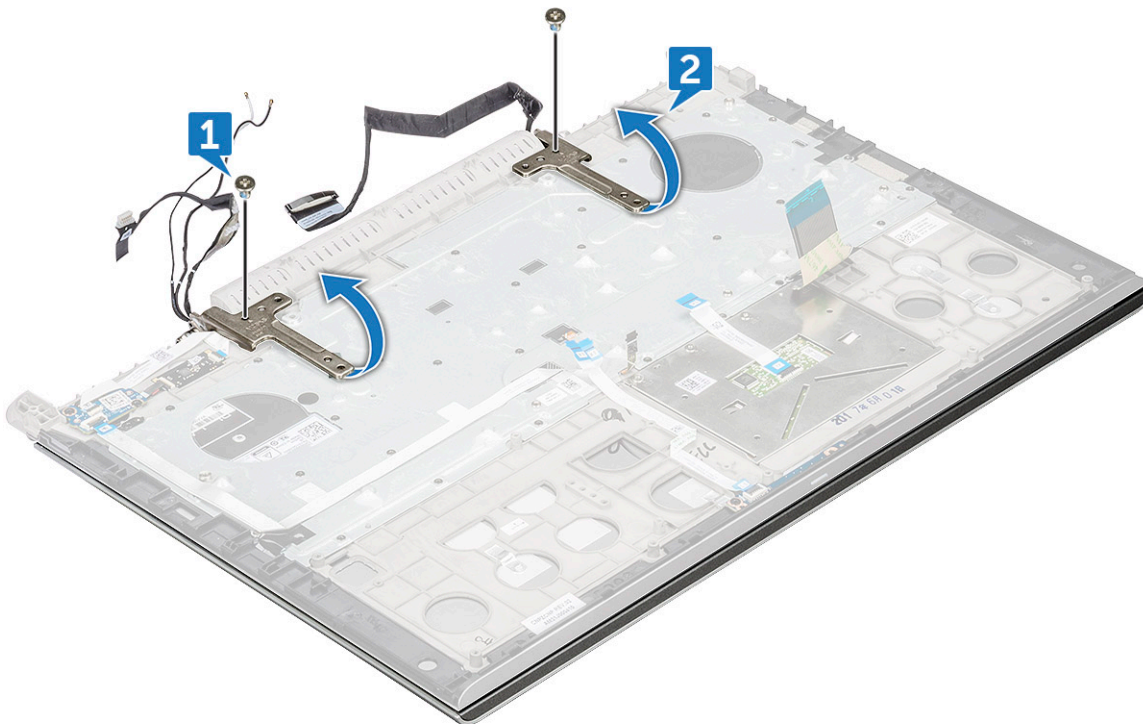

- 4 Slide and lift the display assembly.

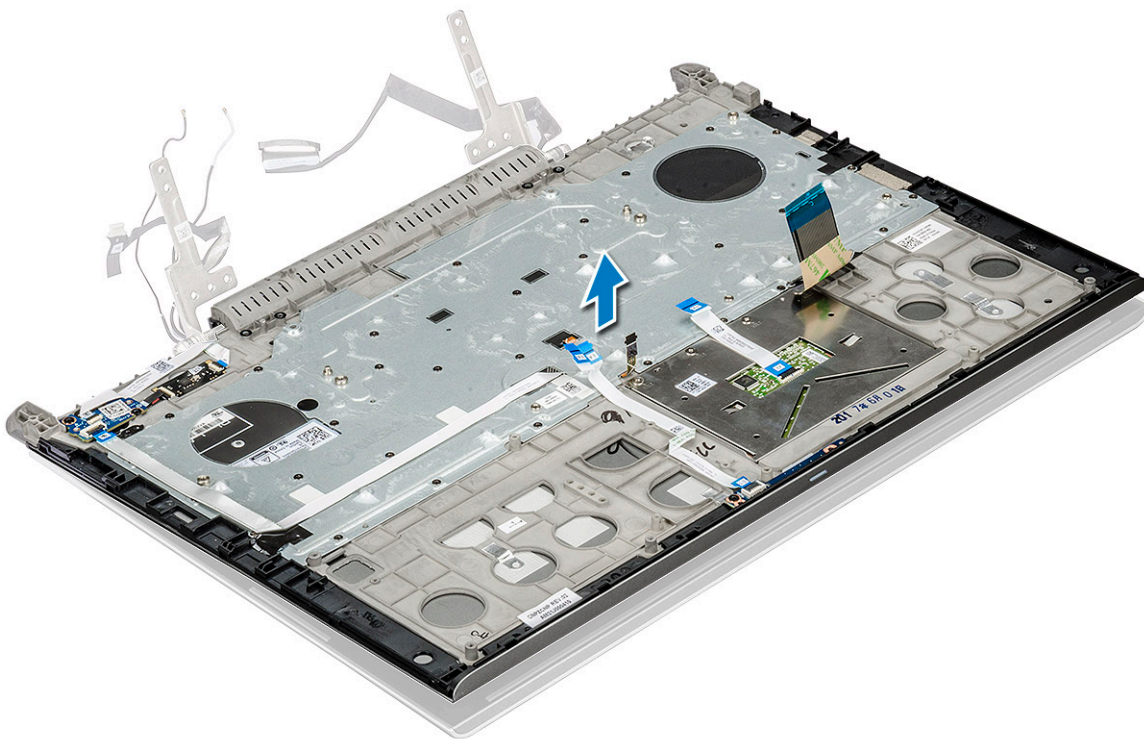

- 5 The component you are left with is the display assembly.



## Installing the display assembly

- 1 Place the display assembly on the computer.
- 2 Place the hinge bracket on the display assembly.
- 3 Replace the M2.5x5L(2) screws that secure the hinge bracket to the display assembly.
- 4 Install the:
  - a back cover
  - b rear cover
  - c memory module
  - d SSD card
  - e battery
  - f base cover
- 5 Follow the procedure in [After working inside your computer](#).

## Palm rest

### Removing the palm rest assembly

- 1 Follow the procedure in [Before working inside your computer](#).
- 2 Remove the:
  - a base cover
  - b battery
  - c coin cell battery
  - d SSD card
  - e memory module
  - f hard drive
  - g WLAN card
  - h rear cover
  - i back cover
  - j touchpad
  - k LED board
  - l power button board
  - m fingerprint reader
  - n keyboard
  - o display assembly
  - p display hinge

 **NOTE:** After the removal of all the components the component that you are left with is the palm rest



- 3 Install the following components on the new palm rest.
  - a [display hinge](#)
  - b [display assembly](#)
  - c [keyboard](#)
  - d [fingerprint reader](#)
  - e [power button board](#)
  - f [LED board](#)
  - g [touchpad](#)
  - h [back cover](#)
  - i [rear cover](#)
  - j [WLAN card](#)
  - k [hard drive](#)
  - l [memory module](#)
  - m [SSD card](#)
  - n [coin cell battery](#)
  - o [battery](#)
  - p [base cover](#)
- 4 Follow the procedure in [After working inside your computer](#)

## Display bezel

### Removing the display bezel

- 1 Follow the procedure in [Before working inside your computer](#).
- 2 Remove the:
  - a [base cover](#)
  - b [battery](#)
  - c [SSD card](#)
  - d [memory module](#)
  - e [rear cover](#)
  - f [back cover](#)

g display assembly

- 3 Using a plastic scribe, pry the edges to release the display bezel from the display assembly [1, 2].

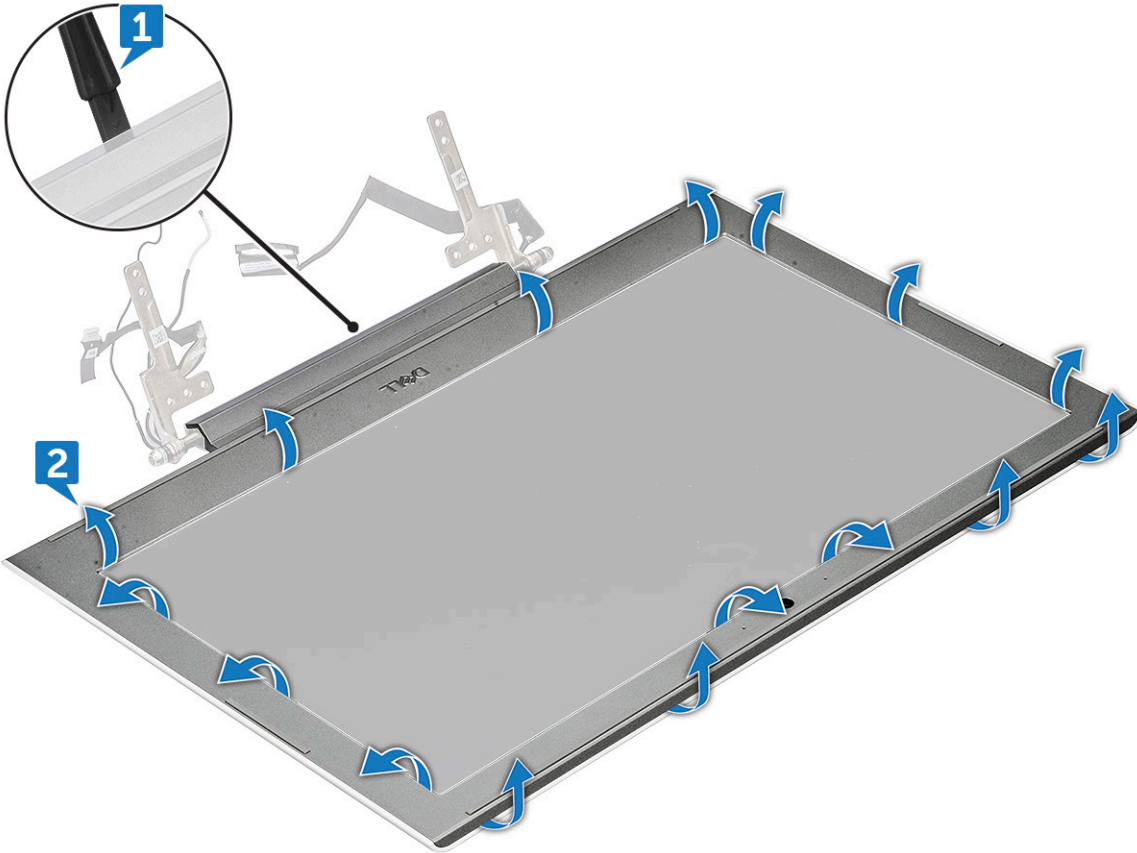

- 4 Remove the display bezel from display assembly.



# Installing the display bezel

- 1 Place the display bezel on the display assembly.
- 2 Starting from the top corner, press on the display bezel and work around the entire bezel until it clicks on to the display assembly.
- 3 Install the:
  - a [display assembly](#)
  - b [back cover](#)
  - c [rear cover](#)
  - d [memory module](#)
  - e [SSD card](#)
  - f [battery](#)
  - g [base cover](#)
- 4 Follow the procedure in [After working inside your computer](#).

## Camera

### Removing the camera

- 1 Follow the procedure in [Before working inside your computer](#).
- 2 Remove the:
  - a [base cover](#)
  - b [battery](#)
  - c [SSD card](#)
  - d [memory module](#)
  - e [rear cover](#)
  - f [back cover](#)
  - g [display assembly](#)
  - h [display bezel](#)
- 3 To remove the camera:
  - a Slide the camera from the display [1].
  - b Disconnect the camera cable from the connector [2].
  - c Lift the camera away from the display [3].

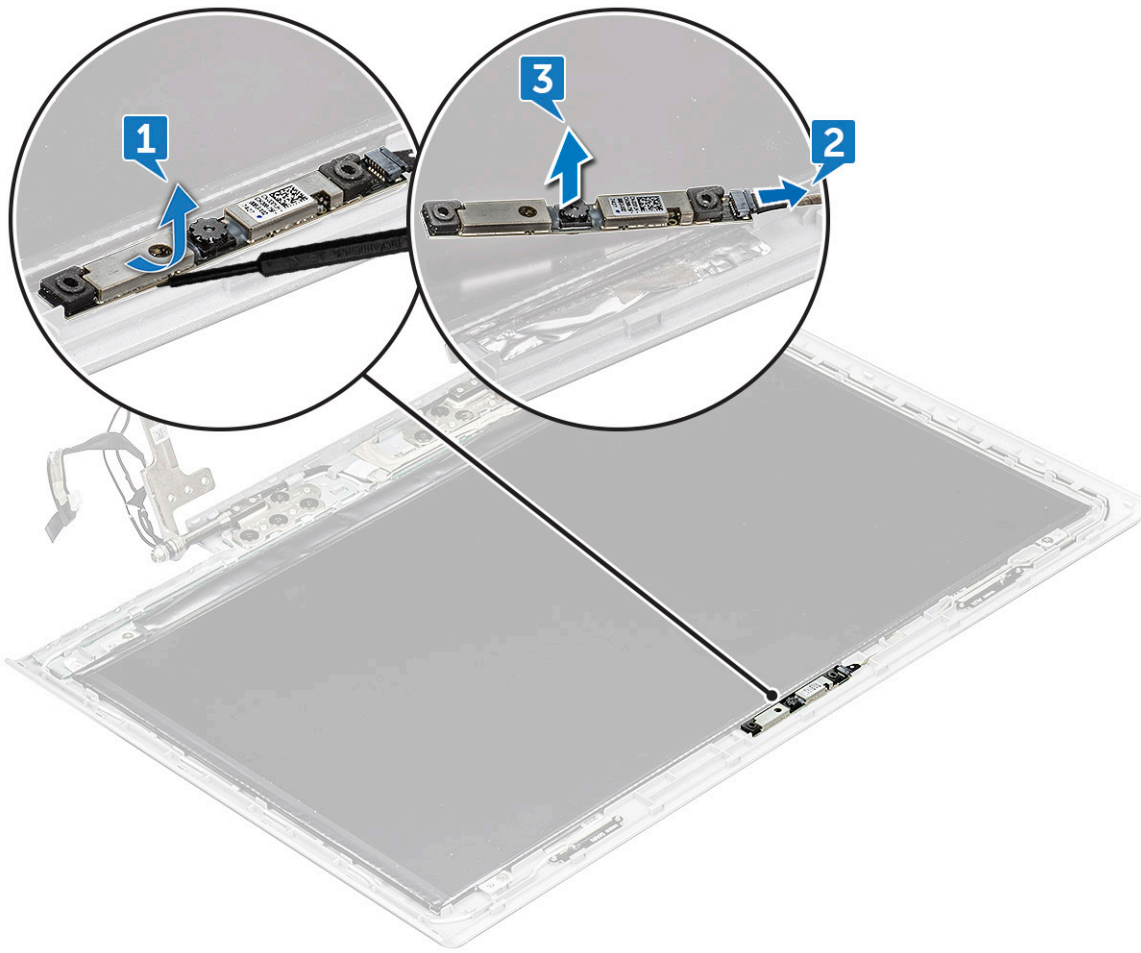

## Installing the camera

- 1 Place the camera on the display assembly.
- 2 Connect the camera cable to the connector on the display assembly.
- 3 Install the:
  - a display bezel
  - b display assembly
  - c back cover
  - d rear cover
  - e memory module
  - f SSD card
  - g battery
  - h base cover
- 4 Follow the procedure in [After working inside your computer](#).

## Display hinges

### Removing the display hinge

- 1 Follow the procedure in [Before working inside your computer](#).
- 2 Remove the:



- a base cover
- b battery
- c SSD card
- d memory module
- e rear cover
- f back cover
- g display assembly
- h display bezel

3 To remove the display hinge:

- a Remove the M2.5x2.5L (8) screws that secure the display hinge to the display assembly [1].
- b Lift the display hinge away from the display assembly [2].

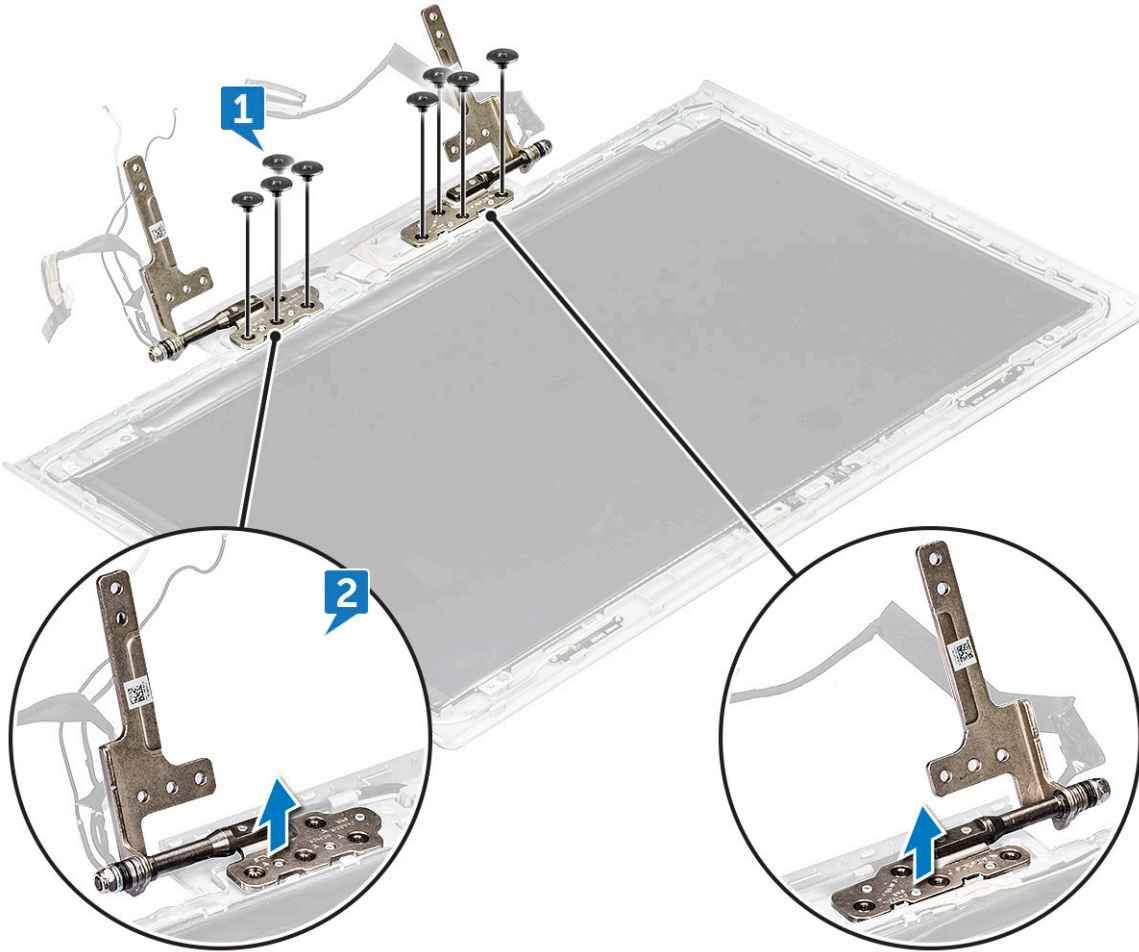

## Installing the display hinge

- 1 Place the display hinge cover on the display assembly.
- 2 Tighten the M2.5x2.5L (8) screws to secure the display hinge cover to the display assembly.
- 3 Install the:
  - a display bezel
  - b display assembly
  - c back cover
  - d rear cover
  - e memory module
  - f SSD card

- g battery
- h base cover

4 Follow the procedure in [After working inside your computer](#).

## Display panel

### Removing the display panel

- 1 Follow the procedure in [Before working inside your computer](#).
- 2 Remove the:
  - a base cover
  - b battery
  - c SSD card
  - d memory module
  - e rear cover
  - f back cover
  - g display assembly
  - h display bezel
  - i display hinge
- 3 Remove the M2x2.5L (4) screws that secure the display panel to the display assembly [1] and lift to turn over the display panel to access the eDP cable [2].



- 4 To remove display panel:
  - a Remove the adhesive tape [1].
  - b Lift the latch and disconnect the display cable from the connector on the display panel [2].
  - c Lift the display panel [3].



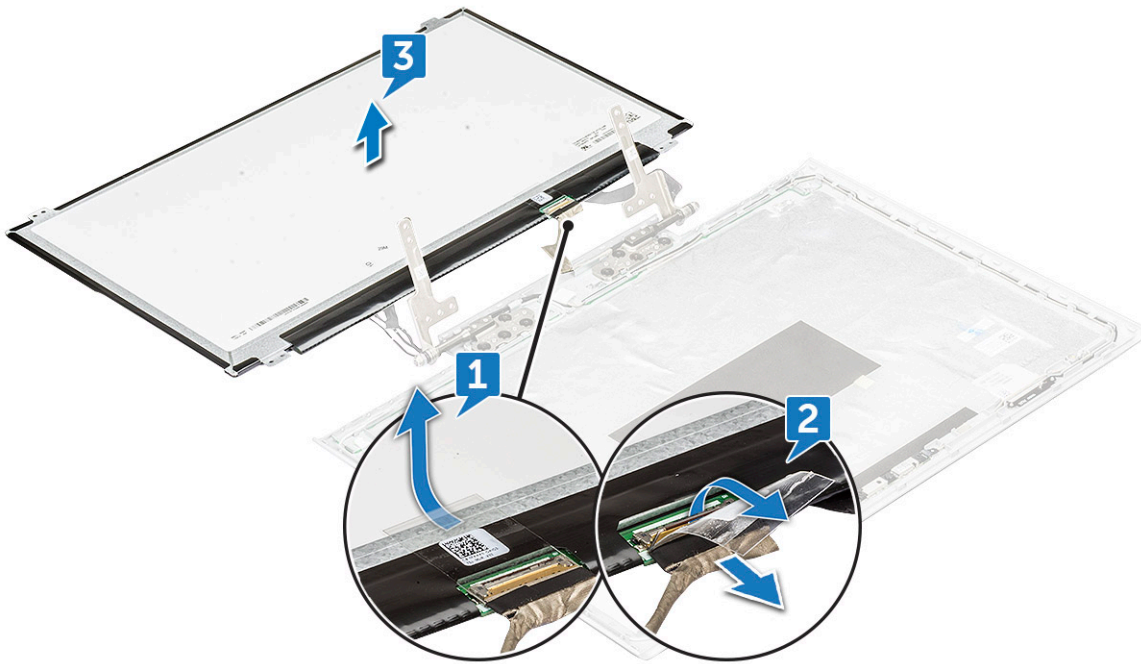

## Installing the display panel

- 1 Connect the eDP cable to the connector.
- 2 Affix the adhesive tape to secure the eDP cable.
- 3 Replace the display panel to align with the screw holders on the display assembly.
- 4 Tighten the M2x2.5L (4) screws to secure the display panel to the display assembly.
- 5 Install the:
  - a display bezel
  - b display assembly
  - c back cover
  - d rear cover
  - e memory module
  - f SSD card
  - g battery
  - h base cover
- 6 Follow the procedure in [After working inside your computer](#).

## eDP cable

## Removing the eDP cable

- 1 Follow the procedure in [Before working inside your computer](#).
- 2 Remove the:
  - a base cover
  - b battery
  - c SSD card
  - d memory module
  - e rear cover

- f back cover
- g display assembly
- h display bezel
- i display hinge
- j display panel

3 Unroute the eDP cable from the routing channel to remove from the display.

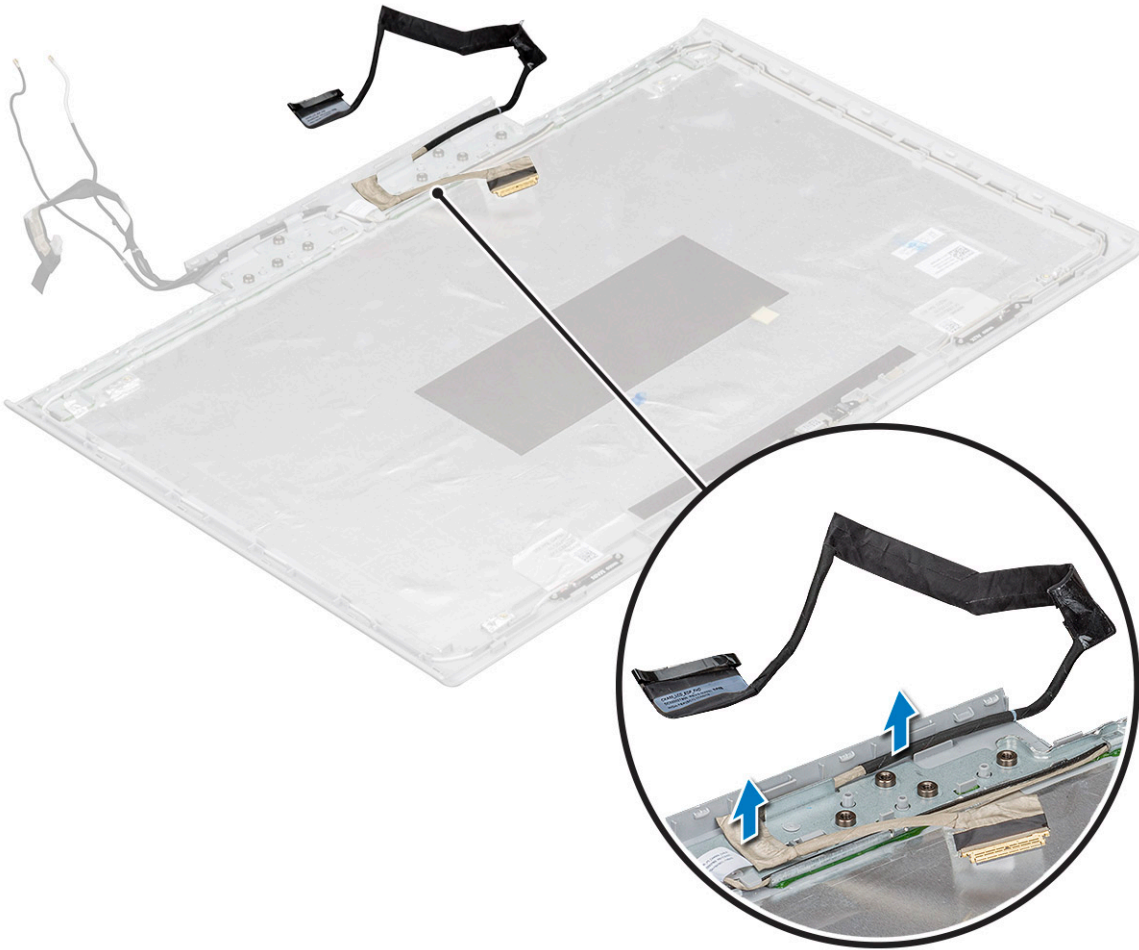

## Installing the eDP cable

- 1 Place the eDP cable on the display panel.
- 2 Route the eDP cable through the routing channel.
- 3 Install the:
  - a display panel
  - b display bezel
  - c display assembly
  - d back cover
  - e rear cover
  - f memory module
  - g SSD card
  - h battery
  - i base cover
- 4 Follow the procedure in [After working inside your computer](#).



# Display back cover assembly

## Removing the display back cover assembly

- 1 Follow the procedure in [Before working inside your computer](#).
- 2 Remove the:
  - a [base cover](#)
  - b [battery](#)
  - c [SSD card](#)
  - d [memory module](#)
  - e [rear cover](#)
  - f [back cover](#)
  - g [display assembly](#)
  - h [display bezel](#)
  - i [display hinge](#)
  - j [display panel](#)
  - k [camera](#)
  - l [eDP cable](#)
- 3 The display back cover assembly is the remaining component, after removing all the components.

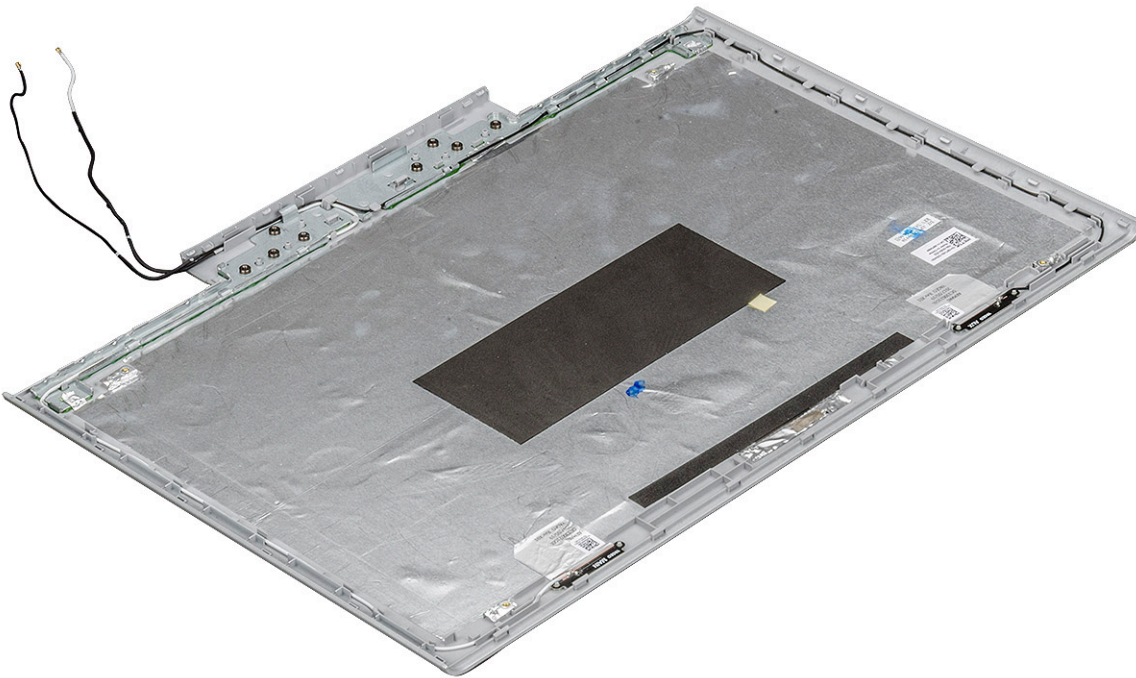

## Installing the display back cover assembly

- 1 The display back cover assembly is the remaining component, after removing all the components.
- 2 Install the:
  - a [eDP cable](#)
  - b [camera](#)
  - c [display panel](#)
  - d [display bezel](#)
  - e [display assembly](#)

- f back cover
- g rear cover
- h memory module
- i SSD card
- j battery
- k base cover

3 Follow the procedure in [After working inside your computer](#).



# Technology and components

This chapter details the technology and components available in the system.

Topics:

- AC Adapters
- HM175
- DDR4
- USB features
- USB Type C
- HDMI 1.4
- Intel HD Graphics 630
- NVIDIA GeForce GTX 1050 Graphics
- NVIDIA GeForce GTX 1050Ti Graphics
- NVIDIA GeForce GTX 1060 Graphics

## AC Adapters



This laptop is shipped with following AC adapter:

- 130 W 3-Pin
- 180 W 3-Pin
- When you disconnect the AC adapter cable from the computer, grasp the connector, not the cable itself, and then pull firmly but gently to avoid damaging the cable.
- The AC adapter works with electrical outlets worldwide. However, power connectors and power strips vary among countries. Using an incompatible cable or improperly connecting the cable to the power strip or electrical outlet may cause fire or equipment damage.

## How to check the status of AC Adapter in BIOS?

- 1 Restart / Power on your computer.
- 2 At the first text on the screen or when the Dell logo appears, tap <F2> until the message **Entering Setup** appears.
- 3 Under **General** > **Battery Information**, you will see **AC Adapter** listed.

## HM175

## Mobile Chipset

The mobile Intel® HM175 Express Chipset is part of the mobile Intel® 7 Series Chipset family.

- It brings in fast I/O capabilities with great flexibility and a host of other power packed features to compliment the performance benefits of mobile 7th Gen Intel® Core™ processor.

- The 100 series PCH offers a host of incremental features compared to the 9 series PCH such as additional USB 3.0 ports and faster data transfer between the processor and the PCH with DMI 3.0.
- The latest Intel® Rapid Storage Technology 15 with Intel® HM175 chipset supports NVMe\* PCIe\* x4 Solid State Drives.

## Features and Benefits

**Table 2. HM175 features and benefits**

Features and Benefits	
Support for Mobile 6th & 7th Gen Intel Core Processors	Support for 6th & 7th Gen Intel® Core™ processors with great power and performance.
Intel® Rapid Recover Technology	Provides excellent levels of performance, responsiveness, and expandability. Take advantage of the enhanced performance and low power consumption available with Intel® RST with one or more SATA or PCIe* storage drives. With additional SATA drives, Intel® RST provides quick access to digital photo, video, and data files with RAID 0, 5, and 10, and excellent data protection against a storage disk drive failure with RAID 1, 5, and 10. Dynamic Storage Accelerator unleashes the maximum performance of Solid State Drives (SSD) when multitasking.
Intel® Identity Protection Technology	Help protect your one-time-password (OTP) credentials.
Intel® High Definition Audio	Integrated audio support enables premium digital surround sound and delivers advanced features such as multiple audio streams and jack re-tasking
Universal Serial Bus 3.1 Gen 1	Integrated USB 3.1 Gen 1 support, provides a design data rate of up to 5 gigabits per second (Gbps) with up to 8 USB 3.1 Gen 1 ports.
USB Port Disable	Enables individual USB ports to be enabled or disabled as needed. This feature provides added protection of data by preventing malicious removal or insertion of data through USB ports.
PCI Express 3.0 interface	Offers up to 8 GT/s for fast access to peripheral devices and networking with up to 16 PCI Express 3.0 ports, configurable as x1, x2, and x4 depending on motherboard designs.
SATA Port Disable	Enables individual SATA ports to be enabled or disabled as needed. This feature provides added protection of data by helping to prevent malicious removal or insertion of data through SATA ports. Especially targeted for eSATA ports.
USB 2.0 rate matching hub	Hi-speed USB 2.0 support with a design data rate of up to 480 megabits per second (Mbps) with up to 14 USB 2.0 ports.
Serial ATA (SATA) 6 Gb/s and 3 Gb/s	High-speed storage interface supporting up to 6 Gb/s transfer rate for improved data access. Provides up to six SATA ports with up to two ports supporting 6 Gb/s transfer rates.
eSATA	SATA interface designed for use with external SATA devices. Provides a link for 3 Gb/s data speeds to eliminate bottlenecks found with current external storage solutions.
Intel® integrated 10/100/1000 MAC	Support for the Intel® I219LM and Intel® I219V Gigabit Network Connection.

**NOTE:** Not all features mentioned here for the HM175 Express chipset may be available for Dell units, please refer to particular system specification for detail.

## DDR4

DDR4 (double data rate fourth generation) memory is a higher-speed successor to the DDR2 and DDR3 technologies and allows up to 512 GB in capacity, compared to the DDR3's maximum of 128 GB per DIMM. DDR4 synchronous dynamic random-access memory is keyed differently from both SDRAM and DDR to prevent the user from installing the wrong type of memory into the system.



DDR4 needs 20 percent less or just 1.2 volts, compared to DDR3 which requires 1.5 volts of electrical power to operate. DDR4 also supports a new, deep power-down mode that allows the host device to go into standby without needing to refresh its memory. Deep power-down mode is expected to reduce standby power consumption by 40 to 50 percent.

## DDR4 Details

There are subtle differences between DDR3 and DDR4 memory modules, as listed below.

### Key notch difference

The key notch on a DDR4 module is in a different location from the key notch on a DDR3 module. Both notches are on the insertion edge but the notch location on the DDR4 is slightly different, to prevent the module from being installed into an incompatible board or platform.

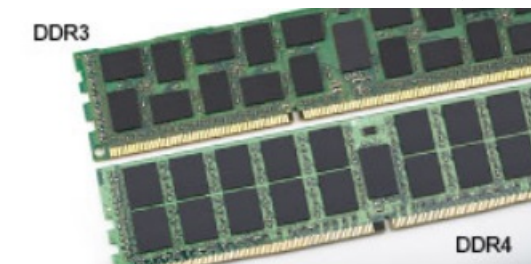

**Figure 1. Notch difference**

### Increased thickness

DDR4 modules are slightly thicker than DDR3, to accommodate more signal layers.

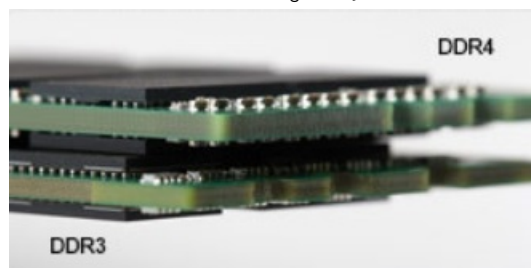

**Figure 2. Thickness difference**

### Curved edge

DDR4 modules feature a curved edge to help with insertion and alleviate stress on the PCB during memory installation.



**Figure 3. Curved edge**

# Memory Errors

Memory errors on the system display the new ON-FLASH-FLASH or ON-FLASH-ON failure code. If all memory fails, the LCD does not turn on. Troubleshoot for possible memory failure by trying known good memory modules in the memory connectors on the bottom of the system or under the keyboard, as in some portable systems.

# USB features

Universal Serial Bus, or USB, was introduced in 1996. It dramatically simplified the connection between host computers and peripheral devices like mice, keyboards, external drives, and printers.

Let's take a quick look on the USB evolution referencing to the table below.

**Table 3. USB evolution**

Type	Data Transfer Rate	Category	Introduction Year
USB 3.0/USB 3.1 Gen 2	5 Gbps	Super Speed	2010
USB 2.0	480 Mbps	High Speed	2000

# USB 3.0/USB 3.1 Gen 1 (SuperSpeed USB)

For years, the USB 2.0 has been firmly entrenched as the de facto interface standard in the PC world with about 6 billion devices sold, and yet the need for more speed grows by ever faster computing hardware and ever greater bandwidth demands. The USB 3.0/USB 3.1 Gen 1 finally has the answer to the consumers' demands with a theoretically 10 times faster than its predecessor. In a nutshell, USB 3.1 Gen 1 features are as follows:

- Higher transfer rates (up to 5 Gbps)
- Increased maximum bus power and increased device current draw to better accommodate power-hungry devices
- New power management features
- Full-duplex data transfers and support for new transfer types
- Backward USB 2.0 compatibility
- New connectors and cable

The topics below cover some of the most commonly asked questions regarding USB 3.0/USB 3.1 Gen 1.



# Speed

Currently, there are 3 speed modes defined by the latest USB 3.0/USB 3.1 Gen 1 specification. They are Super-Speed, Hi-Speed and Full-Speed. The new SuperSpeed mode has a transfer rate of 4.8Gbps. While the specification retains Hi-Speed, and Full-Speed USB mode, commonly known as USB 2.0 and 1.1 respectively, the slower modes still operate at 480Mbps and 12Mbps respectively and are kept to maintain backward compatibility.

USB 3.0/USB 3.1 Gen 1 achieves the much higher performance by the technical changes below:



- An additional physical bus that is added in parallel with the existing USB 2.0 bus (refer to the picture below).
- USB 2.0 previously had four wires (power, ground, and a pair for differential data); USB 3.0/USB 3.1 Gen 1 adds four more for two pairs of differential signals (receive and transmit) for a combined total of eight connections in the connectors and cabling.
- USB 3.0/USB 3.1 Gen 1 utilizes the bidirectional data interface, rather than USB 2.0's half-duplex arrangement. This gives a 10-fold increase in theoretical bandwidth.

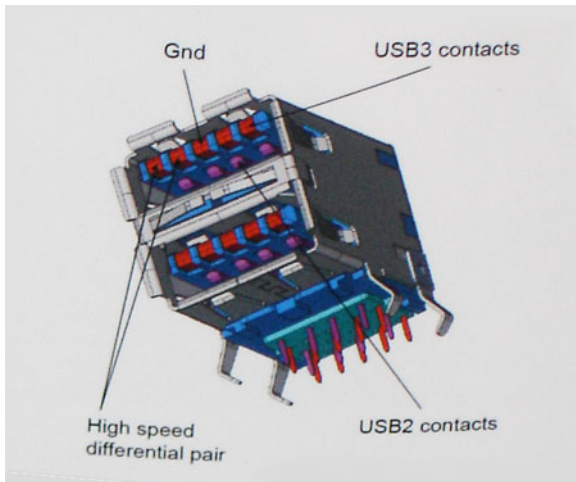

With today's ever increasing demands placed on data transfers with high-definition video content, terabyte storage devices, high megapixel count digital cameras etc., USB 2.0 may not be fast enough. Furthermore, no USB 2.0 connection could ever come close to the 480Mbps theoretical maximum throughput, making data transfer at around 320Mbps (40MB/s) — the actual real-world maximum. Similarly, USB 3.0/USB 3.1 Gen 1 connections will never achieve 4.8Gbps. We will likely see a real-world maximum rate of 400MB/s with overheads. At this speed, USB 3.0/USB 3.1 Gen 1 is a 10x improvement over USB 2.0.

## Applications

USB 3.0/USB 3.1 Gen 1 opens up the laneways and provides more headroom for devices to deliver a better overall experience. Where USB video was barely tolerable previously (both from a maximum resolution, latency, and video compression perspective), it's easy to imagine that with 5-10 times the bandwidth available, USB video solutions should work that much better. Single-link DVI requires almost 2Gbps throughput. Where 480Mbps was limiting, 5Gbps is more than promising. With its promised 4.8Gbps speed, the standard will find its way into some products that previously weren't USB territory, like external RAID storage systems.

Listed below are some of the available SuperSpeed USB 3.0/USB 3.1 Gen 1 products:

- External Desktop USB 3.0/USB 3.1 Gen 1 Hard Drives
- Portable USB 3.0/USB 3.1 Gen 1 Hard Drives
- USB 3.0/USB 3.1 Gen 1 Drive Docks & Adapters
- USB 3.0/USB 3.1 Gen 1 Flash Drives & Readers
- USB 3.0/USB 3.1 Gen 1 Solid-state Drives
- USB 3.0/USB 3.1 Gen 1 RAIDs
- Optical Media Drives
- Multimedia Devices
- Networking
- USB 3.0/USB 3.1 Gen 1 Adapter Cards & Hubs

## Compatibility

The good news is that USB 3.0/USB 3.1 Gen 1 has been carefully planned from the start to peacefully co-exist with USB 2.0. First of all, while USB 3.0/USB 3.1 Gen 1 specifies new physical connections and thus new cables to take advantage of the higher speed capability of

the new protocol, the connector itself remains the same rectangular shape with the four USB 2.0 contacts in the exact same location as before. Five new connections to carry receive and transmitted data independently are present on USB 3.0/USB 3.1 Gen 1 cables and only come into contact when connected to a proper SuperSpeed USB connection.

Windows 8/10 will be bringing native support for USB 3.1 Gen 1 controllers. This is in contrast to previous versions of Windows, which continue to require separate drivers for USB 3.0/USB 3.1 Gen 1 controllers.

Microsoft announced that Windows 7 would have USB 3.1 Gen 1 support, perhaps not on its immediate release, but in a subsequent Service Pack or update. It is not out of the question to think that following a successful release of USB 3.0/USB 3.1 Gen 1 support in Windows 7, SuperSpeed support would trickle down to Vista. Microsoft has confirmed this by stating that most of their partners share the opinion that Vista should also support USB 3.0/USB 3.1 Gen 1.

Super-Speed support for Windows XP is unknown at this point. Given that XP is a seven-year-old operating system, the likelihood of this happening is remote.

## USB Type C

USB Type-C is a new, tiny physical connector. The connector itself can support various exciting new USB standard like USB 3.1 and USB power delivery (USB PD).

### Alternate Mode

USB Type-C is a new connector standard that's very small. It's about a third the size of an old USB Type-A plug. This is a single connector standard that every device should be able to use. USB Type-C ports can support a variety of different protocols using "alternate modes," which allows you to have adapters that can output HDMI, VGA, DisplayPort, or other types of connections from that single USB port

### USB Power Delivery

The USB PD specification is also closely intertwined with USB Type-C. Currently, smartphones, tablets, and other mobile devices often use a USB connection to charge. A USB 2.0 connection provides up to 2.5 watts of power — that'll charge your phone, but that's about it. A laptop might require up to 60 watts, for example. The USB Power Delivery specification ups this power delivery to 100 watts. It's bi-directional, so a device can either send or receive power. And this power can be transferred at the same time the device is transmitting data across the connection.

This could spell the end of all those proprietary laptop charging cables, with everything charging via a standard USB connection. You could charge your laptop from one of those portable battery packs you charge your smartphones and other portable devices from today. You could plug your laptop into an external display connected to a power cable, and that external display would charge your laptop as you used it as an external display — all via the one little USB Type-C connection. To use this, the device and the cable have to support USB Power Delivery. Just having a USB Type-C connection doesn't necessarily mean they do.

## USB Type C and USB 3.1

USB 3.1 is a new USB standard. USB 3's theoretical bandwidth is 5 Gbps, while USB 3.1's is 10 Gbps. That's double the bandwidth, as fast as a first-generation Thunderbolt connector. USB Type-C isn't the same thing as USB 3.1. USB Type-C is just a connector shape, and the underlying technology could just be USB 2 or USB 3.0. In fact, Nokia's N1 Android tablet uses a USB Type-C connector, but underneath it's all USB 2.0 — not even USB 3.0. However, these technologies are closely related.



# HDMI 1.4

This topic explains the HDMI 1.4 and its features along with the advantages.

HDMI (High-Definition Multimedia Interface) is an industry-supported, uncompressed, all-digital audio/video interface. HDMI provides an interface between any compatible digital audio/video source, such as a DVD player, or A/V receiver and a compatible digital audio and/or video monitor, such as a digital TV (DTV). The intended applications for HDMI TVs, and DVD players. The primary advantage is cable reduction and content protection provisions. HDMI supports standard, enhanced, or high-definition video, plus multichannel digital audio on a single cable.

**NOTE:** The HDMI 1.4 will provide 5.1 channel audio support.

## HDMI 1.4 Features

- **HDMI Ethernet Channel** - Adds high-speed networking to an HDMI link, allowing users to take full advantage of their IP-enabled devices without a separate Ethernet cable
- **Audio Return Channel** - Allows an HDMI-connected TV with a built-in tuner to send audio data "upstream" to a surround audio system, eliminating the need for a separate audio cable
- **3D** - Defines input/output protocols for major 3D video formats, paving the way for true 3D gaming and 3D home theater applications
- **Content Type** - Real-time signaling of content types between display and source devices, enabling a TV to optimize picture settings based on content type
- **Additional Color Spaces** - Adds support for additional color models used in digital photography and computer graphics
- **4 K Support** - Enables video resolutions far beyond 1080p, supporting next-generation displays that will rival the Digital Cinema systems used in many commercial movie theaters
- **HDMI Micro Connector** - A new, smaller connector for phones and other portable devices, supporting video resolutions up to 1080p
- **Automotive Connection System** - New cables and connectors for automotive video systems, designed to meet the unique demands of the motoring environment while delivering true HD quality

## Advantages of HDMI

- Quality HDMI transfers uncompressed digital audio and video for the highest, crispest image quality.
- Low -cost HDMI provides the quality and functionality of a digital interface while also supporting uncompressed video formats in a simple, cost-effective manner
- Audio HDMI supports multiple audio formats from standard stereo to multichannel surround sound
- HDMI combines video and multichannel audio into a single cable, eliminating the cost, complexity, and confusion of multiple cables currently used in A/V systems
- HDMI supports communication between the video source (such as a DVD player) and the DTV, enabling new functionality

## Intel HD Graphics 630

The Intel HD Graphics 630 (GT2) is an integrated graphics unit, which can be found in various desktop and notebook processors of the Kaby lake generation. All the Intel's 7th generation Core i7, i5, i3, and High-performance Mobile Processors use the Intel HD 630 as their integrated GPU..

It is manufactured using the 14nm+ technology with minor architectural improvements over the previous generation. The base frequency is 300MHz while the max frequency is 1,150 MHz. However, in the case of some Processors, the base and max frequency is slightly different. It will have the same memory type as your RAM as it is an integrated GPU. Its max Video Memory (VRAM) can be changed from the BIOS settings.

## Features

- Support for up to three independent displays via HDMI 1.4, DisplayPort (DP) 1.2, an Embedded DisplayPort (eDP) 1.4 interfaces.
- Quick Sync Video
- Clear Video
- Clear Video HD

## Power Consumption

The HD Graphics 630 can be found in several notebook and desktop processors of different TDP classes (35 — 91 W).

## Key Specifications

The following table contains the key specifications of the Intel HD Graphics 630:

**Table 4. Key Specifications**

Specification	Intel HD Graphics 630
HD Graphics Series	HD Graphics 630
Codename	Kaby-Lake-H-GT2
Architecture	Intel Gen 9.5 (Kaby lake)
Pipelines	24 — unified
Core Speed *	300 — 1150 (Boost) MHz * The specified clock rates are only guidelines for the manufacturer and can be altered by them.
Memory Bus Width	64/128 bit
Shared Memory	Yes
Technology	14 nm
Features	QuickSync
DirectX	DirectX 12 (FL 12_1)

## NVIDIA GeForce GTX 1050 Graphics

The Nvidia GTX 1050 is a mainstream GPU based on the Pascal architecture and was announced in January 2017. Contrary to the faster models, the GTX 1050 uses the GP107 chip.

## Features

The GP107 chip is manufactured in a 14 nm FinFET process at Samsung and offers a number of new features, including support for DisplayPort 1.4 (ready), HDMI 2.0b, HDR, Simultaneous Multi-Projection (SMP) as well as improved H.265 video de- and encoding (PlayReady 3.0).



## Power Consumption

The NVIDIA GeForce GTX 1050 Graphics can be found in several notebook and desktop processors of different TDP classes (40 — 50 W).

## Key Specifications

The following table contains the key specifications of the NVIDIA GeForce GTX 1050:

**Table 5. Key Specifications**

Specification	NVIDIA GeForce GTX 1050
HD Graphics Series	NVIDIA GeForce GTX 1050
Codename	N17P-G0
Architecture	Pascal
Pipelines	640 - unified
Core Speed *	1354 - 1493 (Boost) MHz
Memory Bus Width	7000 MHz
Shared Memory	No
Technology	14 nm
Features	Multi-Projection, G-SYNC, Vulkan, Multi Monitor
DirectX	DirectX 12_1

## NVIDIA GeForce GTX 1050Ti Graphics

The Nvidia GTX 1050 Ti is a mainstream GPU based on the Pascal architecture and was announced in January 2017. Contrary to the faster models, the GTX 1050 Ti uses the GP107 chip.

## Features

The GP107 chip is manufactured in a 14 nm FinFET process at Samsung and offers a number of new features, including support for DisplayPort 1.4 (ready), HDMI 2.0b, HDR, Simultaneous Multi-Projection (SMP) as well as improved H.265 video de- and encoding (PlayReady 3.0).

## Power Consumption

The NVIDIA GeForce GTX 1050 Ti Graphics can be found in several notebook and desktop processors of different TDP classes (70 W).

## Key Specifications

The following table contains the key specifications of the NVIDIA GeForce GTX 1050 Ti:

**Table 6. Key Specifications**

<b>Specification</b>	<b>NVIDIA GeForce GTX 1050 Ti</b>
HD Graphics Series	NVIDIA GeForce GTX 1050 Ti
Codename	N17P-G1
Architecture	Pascal
Pipelines	768 - unified
Core Speed *	1493 - 1620 (Boost) MHz
Memory Bus Width	7000 MHz
Shared Memory	No
Technology	14 nm
Features	Multi-Projection, G-SYNC, Vulkan, Multi Monitor
DirectX	DirectX 12_1

## NVIDIA GeForce GTX 1060 Graphics

The mobile Nvidia GeForce GTX 1060 is a graphics card for high end laptops. It is based on the Pascal architecture and manufactured in 16 nm FinFET at TSMC. The GPU is using the smaller GP106 chip. Compared to the desktop version of the GTX 1060, the laptop version offers the same amount of shader but slightly lower clock rates.

### Features

The GP106 chip is produced in 16nm FinFET at TSMC and offers a range of new features, like DisplayPort 1.4 (ready), HDMI 2.0b, HDR, Simultaneous Multi-Projection (SMP) and improved H.265 video de- and encoding (PlayReady 3.0).

### Power Consumption

NVIDIA GeForce GTX 1060 Graphics can be found in several notebook and desktop processors of different TDP classes (80 W).

### Key Specifications

The following table contains the key specifications of the NVIDIA GeForce GTX 1060:

**Table 7. Key Specifications**

<b>Specification</b>	<b>NVIDIA GeForce GTX 1060</b>
HD Graphics Series	NVIDIA GeForce GTX 1060
Codename	N17P-G1
Architecture	Pascal
Pipelines	1280 - unified
Core Speed *	1506 - 1708 (Boost) MHz
Memory Bus Width	8000 MHz



**Specification****NVIDIA GeForce GTX 1060**

---

Shared Memory	No
Technology	16 nm
Features	Multi-Projection, G-SYNC, Vulkan, Multi Monitor
DirectX	DirectX 12_1



# System setup

System setup enables you to manage your tablet/desktop/notebook hardware and specify BIOS level options. From the System setup, you can:

- Change the NVRAM settings after you add or remove hardware
- View the system hardware configuration
- Enable or disable integrated devices
- Set performance and power management thresholds
- Manage your computer security

Topics:

- [Boot menu](#)
- [Navigation keys](#)
- [System setup options](#)
- [Updating the BIOS in Windows](#)
- [System and setup password](#)

## Boot menu

Press <F12> when the Dell logo appears to initiate a one-time boot menu with a list of the valid boot devices for the system. Diagnostics and BIOS Setup options are also included in this menu. The devices listed on the boot menu depend on the bootable devices in the system. This menu is useful when you are attempting to boot to a particular device or to bring up the diagnostics for the system. Using the boot menu does not make any changes to the boot order stored in the BIOS.

The options are:

- UEFI Boot:
  - Windows Boot Manager
- Other Options:
  - BIOS Setup
  - BIOS Flash Update
  - Diagnostics
  - Change Boot Mode Settings

## Navigation keys

**NOTE:** For most of the System Setup options, changes that you make are recorded but do not take effect until you restart the system.

Keys	Navigation
Up arrow	Moves to the previous field.
Down arrow	Moves to the next field.



<b>Keys</b>	<b>Navigation</b>
<b>Enter</b>	Selects a value in the selected field (if applicable) or follow the link in the field.
<b>Spacebar</b>	Expands or collapses a drop-down list, if applicable.
<b>Tab</b>	Moves to the next focus area.
	   <b>NOTE: For the standard graphics browser only.</b>
<b>Esc</b>	Moves to the previous page until you view the main screen. Pressing Esc in the main screen displays a message that prompts you to save any unsaved changes and restarts the system.

## System setup options

 | **NOTE: Depending on the tablet/notebook and its installed devices, the items listed in this section may or may not appear.**

## General screen options

This section lists the primary hardware features of your computer.

Option	Description
<b>System Information</b>	<p>This section lists the primary hardware features of your computer.</p> <ul style="list-style-type: none"> <li>System Information: Displays BIOS Version, Service Tag, Asset Tag, Ownership Tag, Manufacture Date, Ownership Date, and the Express Service Code.</li> <li>Memory Information: Displays Memory Installed, Memory Available, Memory Speed, Memory Channels Mode, Memory Technology, DIMM A Size, DIMM B Size</li> <li>Processor Information: Displays Processor Type, Core Count, Processor ID, Current Clock Speed, Minimum Clock Speed, Maximum Clock Speed, Processor L2 Cache, Processor L3 Cache, HT Capable, and 64-Bit Technology.</li> <li>Device Information: Displays M.2 SATA, Primary Hard Drive, M.2 PCIe SSD-0, LOM MAC Address, dGPU Video Controller, Video BIOS Version, Video Memory, Panel Type, Native Resolution, Audio Controller, Wi-Fi Device, Bluetooth Device.</li> </ul>
<b>Battery Information</b>	Displays the battery status and the type of AC adapter connected to the computer.
<b>Boot Sequence</b>	<p>Allows you to change the order in which the computer attempts to find an operating system.</p> <ul style="list-style-type: none"> <li>Windows Boot Manager</li> <li>Boot list options: <ul style="list-style-type: none"> <li>Legacy</li> <li>UEFI (selected by default)</li> </ul> </li> </ul>
<b>Advanced Boot Options</b>	<p>This option allows you the legacy option ROMs to load. By default, the <b>Enable Legacy Option ROMs</b> is enabled.</p> <ul style="list-style-type: none"> <li>Enable Attempt Legacy Boot</li> </ul>
<b>Date/Time</b>	Allows you to change the date and time.

# System Configuration screen options

Option	Description
<b>Integrated NIC</b>	<p>Allows you to configure the integrated network controller. The options are:</p> <ul style="list-style-type: none"><li>· Disabled</li><li>· Enabled</li><li>· Enabled w/PXE: This option is enabled by default.</li></ul>
<b>SATA Operation</b>	<p>Allows you to configure the internal SATA hard-drive controller. The options are:</p> <ul style="list-style-type: none"><li>· Disabled</li><li>· AHCI</li><li>· RAID On: This option is enabled by default.</li></ul>
<b>Drives</b>	<p>Allows you to configure the SATA drives on board. All drives are enabled by default. The options are:</p> <ul style="list-style-type: none"><li>· SATA-0</li><li>· SATA-1</li><li>· M.2 PCI-e SSD-0</li></ul>
<b>SMART Reporting</b>	<p>This field controls whether hard drive errors for integrated drives are reported during system startup. This technology is part of the SMART (Self Monitoring Analysis and Reporting Technology) specification. This option is disabled by default.</p> <ul style="list-style-type: none"><li>· Enable SMART Reporting</li></ul>
<b>USB Configuration</b>	<p>This is an optional feature.</p> <p>This field configures the integrated USB controller. If Boot Support is enabled, the system is allowed to boot any type of USB Mass Storage Devices (HDD, memory key, floppy).</p> <p>If USB port is enabled, device attached to this port is enabled and available for OS.</p> <p>If USB port is disabled, the OS cannot see any device attached to this port.</p> <p>The options are:</p> <ul style="list-style-type: none"><li>· Enable Boot support (by default enable)</li><li>· Enable external USB ports</li></ul> <p><b>NOTE: USB keyboard and mouse always work in the BIOS setup irrespective of these settings.</b></p>
<b>Thunderbolt Adapter Configuration</b>	<p>The options for Thunderbolt Adapter Configuration are:</p> <ul style="list-style-type: none"><li>· Enable Thunderbolt Technology Support (selected by default)</li><li>· Enable Thunderbolt Adapter Boot Support</li><li>· Enable Thunderbolt Adapter Pre-boot Modules</li><li>· Security Level — No Security</li><li>· Security Level — User Authorization (selected by default)</li><li>· Security Level — Secure Connect</li><li>· Security Level — Display Port Only</li></ul>





Option	Description
<b>USB PowerShare</b>	This field configures the USB PowerShare feature behavior. This option allows you to charge external devices using the stored system battery power through the USB PowerShare port (disabled by default).
<b>Audio</b>	This field enables or disables the integrated audio controller. By default, the <b>Enable Audio</b> option is selected. The options are: <ul style="list-style-type: none"> <li>· Enable Microphone (by default enable)</li> <li>· Enable Internal Speaker (by default enable)</li> </ul>
<b>Keyboard Illumination</b>	This field lets you choose the operating mode of the keyboard illumination feature. The keyboard brightness level can be set from 0% to 100%. The options are: <ul style="list-style-type: none"> <li>· Disabled</li> <li>· Dim</li> <li>· Bright (selected by default)</li> </ul>
<b>Keyboard Backlight with AC</b>	The Keyboard Backlight with AC option does not affect the main keyboard illumination feature. Keyboard Illumination will continue to support the various illumination levels. This field has an effect when the backlight is enabled (selected by default).
<b>Miscellaneous Devices</b>	Allows you to enable or disable the following devices: <ul style="list-style-type: none"> <li>· Enable Camera (selected by default)</li> <li>· Enable HardDrive Free Fall Protection (selected by default)</li> </ul>

## Video screen options

Option	Description
<b>LCD Brightness</b>	Allows you to set the display brightness depending upon the power source. On Battery(50% is default) and On AC (100 % default).

## Security screen options

Option	Description
<b>Admin Password</b>	Allows you to set, change, or delete the administrator (admin) password. <ul style="list-style-type: none"> <li>ⓘ <b>NOTE: You must set the admin password before you set the system or hard drive password. Deleting the admin password automatically deletes the system password and the hard drive password.</b></li> <li>ⓘ <b>NOTE: Successful password changes take effect immediately.</b></li> </ul> Default setting: Not set
<b>System Password</b>	Allows you to set, change or delete the system password. <ul style="list-style-type: none"> <li>ⓘ <b>NOTE: Successful password changes take effect immediately.</b></li> </ul> Default setting: Not set
<b>M.2 SATA SSD Password</b>	Allows you to set, change or delete the M.2 SATA SSD.

Option	Description
	<p> <b>NOTE: Successful password changes take effect immediately.</b></p> <p>Default setting: Not set</p>
<b>Strong Password</b>	<p>Allows you to enforce the option to always set strong passwords.</p> <p>Default Setting: Enable Strong Password is not selected.</p> <p> <b>NOTE: If Strong Password is enabled, Admin and System passwords must contain at least one uppercase character, one lowercase character and be at least 8 characters long.</b></p>
<b>Password Configuration</b>	<p>Allows you to specify the minimum and max password lengths of Administrator and System passwords.</p> <ul style="list-style-type: none"> <li>· minimum -4 (by default, if you want to change you can increase the number)</li> <li>· maximum -32 ( you can decrease the number)</li> </ul>
<b>Password Bypass</b>	<p>Allows you to enable or disable the permission to bypass the System and the Internal HDD password, when they are set. The options are:</p> <ul style="list-style-type: none"> <li>· Disabled</li> <li>· Reboot bypass</li> </ul> <p>Default setting: Disabled</p>
<b>Password Change</b>	<p>Allows you to enable the disable permission to the System and Hard Drive passwords when the admin password is set.</p> <p>Default setting: <b>Allow Non-Admin Password Changes</b> is selected.</p>
<b>Non-Admin Setup Changes</b>	<p>Allows you to determine whether changes to the setup options are allowed when an Administrator Password is set. If disabled the setup options are locked by the admin password.</p> <ul style="list-style-type: none"> <li>· allow wireless switch changes</li> </ul>
<b>UEFI Capsule Firmware Updates</b>	<p>Allows you to enable or disable. This option controls whether this system allows BIOS updated via UEFI capsule update packages. The options are:</p> <ul style="list-style-type: none"> <li>· Enable UEFI Capsule Firmware—enabled by default</li> </ul>
<b>TPM 2.0 Security</b>	<p>Allows you to enable the Trusted Platform Module (TPM) during POST. The options are:</p> <ul style="list-style-type: none"> <li>· TPM On (selected by default)</li> <li>· Clear (option is disabled)</li> <li>· PPI Bypass for Enabled Commands (selected by default)</li> <li>· PPI Bypass for Disabled Commands</li> <li>· Disabled</li> <li>· Enabled</li> <li>· Attestation enable (selected by default)</li> <li>· Key storage enable (selected by default)</li> <li>· SHA-256 (selected by default)</li> </ul> <p> <b>NOTE: To upgrade or downgrade TPM1.2/2.0, download the TPM wrapper tool (software).</b></p>
<b>Computrace</b>	<p>Allows you to activate or disable the optional Computrace software The options are:</p> <ul style="list-style-type: none"> <li>· Deactivate</li> </ul>



Option	Description
	<ul style="list-style-type: none"> <li>· Disable</li> <li>· Activate (selected by default)</li> </ul> <p><b>NOTE:</b> The Activate and Disable options will permanently activate or disable the feature and no further changes will be allowed</p>
<b>CPU XD Support</b>	<p>Allows you to enable the Execute Disable mode of the processor.</p> <p>Enable CPU XD Support (default)</p>
<b>OROM Keyboard Access</b>	<p>Allows you to set an option to enter the Option ROM Configuration screens using hotkeys during boot. The options are:</p> <ul style="list-style-type: none"> <li>· Enable</li> <li>· One Time Enable</li> <li>· Disable</li> </ul> <p>Default setting: Enable</p>
<b>Admin Setup Lockout</b>	<p>Allows you to prevent users from entering Setup when an Administrator password is set.</p> <p>Default Setting: <b>Disabled</b></p>
<b>Master password lockout</b>	<p>This option is not selected by default</p>

## Secure Boot screen options

Option	Description
<b>Secure Boot Enable</b>	<p>This option enables or disables the <b>Secure Boot</b> feature.</p> <ul style="list-style-type: none"> <li>· Disabled</li> <li>· Enabled</li> </ul> <p>Default setting: Enabled.</p>
<b>Expert Key Management</b>	<p>Allows you to manipulate the security key databases only if the system is in Custom Mode. The Enable Custom Mode option is disabled by default. The options are:</p> <ul style="list-style-type: none"> <li>· PK—enabled by default</li> <li>· KEK</li> <li>· db</li> <li>· dbx</li> </ul> <p>If you enable the Custom Mode, the relevant options for PK, KEK, db, and dbx appear. The options are:</p> <ul style="list-style-type: none"> <li>· Save to File—Saves the key to a user-selected file</li> <li>· Replace from File—Replaces the current key with a key from a user-selected file</li> <li>· Append from File—Adds a key to the current database from a user-selected file</li> <li>· Delete—Deletes the selected key</li> <li>· Reset All Keys—Resets to default setting</li> <li>· Delete All Keys—Deletes all the keys</li> </ul>

Option	Description
	 <b>NOTE:</b> If you disable the Custom Mode, all the changes made are erased and the keys restore to default settings.

## Intel Software Guard Extensions screen options

Option	Description
<b>Intel SGX Enable</b>	This field specifies you to provide a secured environment for running code/storing sensitive information in the context of the main OS. The options are: <ul style="list-style-type: none"> <li>· Disabled</li> <li>· Enabled</li> <li>· Software controlled (default)</li> </ul>
<b>Enclave Memory Size</b>	This option sets <b>SGX Enclave Reserve Memory Size</b> . The options are: <ul style="list-style-type: none"> <li>· 32 MB</li> <li>· 64 MB</li> <li>· 128 MB (default)</li> </ul>

## Performance screen options

Option	Description
<b>Multi Core Support</b>	This field specifies whether the process has one or all cores enabled. The performance of some applications improves with the additional cores. <ul style="list-style-type: none"> <li>· All (selected by default)</li> <li>· 1</li> <li>· 2</li> <li>· 3</li> </ul>
<b>Intel SpeedStep</b>	Allows you to enable or disable the Intel SpeedStep feature. <ul style="list-style-type: none"> <li>· Enable Intel SpeedStep</li> </ul> Default setting: The option is enabled.
<b>C-States Control</b>	Allows you to enable or disable the additional processor sleep states. <ul style="list-style-type: none"> <li>· C states</li> </ul> Default setting: The option is enabled.
<b>Intel TurboBoost</b>	Allows you to enable or disable the Intel TurboBoost mode of the processor. <ul style="list-style-type: none"> <li>· Enable Intel TurboBoost</li> </ul> Default setting: The option is enabled.



# Power Management screen options

Option	Description
<b>AC Behavior</b>	Allows you to enable or disable the computer from turning on automatically when an AC adapter is connected. Default setting: Wake on AC is not selected.
<b>Enable Intel Speed Shift Technology</b>	Allows you to enable or disable the Intel Speed Shift Technology. Default setting: Enabled
<b>Auto On Time</b>	Allows you to set the time at which the computer must turn on automatically. The options are: <ul style="list-style-type: none"><li>· Disabled</li><li>· Every Day</li><li>· Weekdays</li><li>· Select Days</li></ul> Default setting: Disabled
<b>USB Wake Support</b>	Allows you to enable USB devices to wake the system from Standby. <p><b>NOTE:</b> This feature is only functional when the AC power adapter is connected. If the AC power adapter is removed during Standby, the system setup removes power from all the USB ports to conserve battery power.</p> <ul style="list-style-type: none"><li>· Enable USB Wake Support</li></ul>
<b>Wake on LAN</b>	Allows you to enable or disable the feature that powers on the computer from the Off state when triggered by a LAN signal. <ul style="list-style-type: none"><li>· Disabled (Enabled)</li><li>· LAN Only</li></ul>
<b>Advanced Battery Charge Configuration</b>	This option enables you to maximize the battery health. By enabling this option, your system uses the standard charging algorithm and other techniques, during the non-work hours to improve the battery health.
<b>Primary Battery Charge Configuration</b>	Allows you to select the charging mode for the battery. The options are: <ul style="list-style-type: none"><li>· Adaptive (default)</li><li>· Standard — Fully charges your battery at a standard rate.</li><li>· ExpressCharge — The battery charges over a shorter period of time using Dell's fast charging technology. This option is enabled by default.</li><li>· Primarily AC use</li><li>· Custom</li></ul> If Custom Charge is selected, you can also configure Custom Charge Start and Custom Charge Stop. <p><b>NOTE:</b> All charging mode may not be available for all the batteries. To enable this option, disable the Advanced Battery Charge Configuration option.</p>
<b>Type-C connector power</b>	<ul style="list-style-type: none"><li>· 7.5 Watts(selected by default)</li><li>· 15 Watts</li></ul>

# POST Behavior screen options

Option	Description
<b>Adapter Warnings</b>	Allows you to enable or disable the system setup (BIOS) warning messages when you use certain power adapters. Default setting: Enable Adapter Warnings
<b>Numlock Enable</b>	Allows you to enable the Numlock option when the computer boots. Enable Network. This option is enabled by default.
<b>Fn Lock Options</b>	Allows you to let hot key combinations Fn + Esc toggle the primary behavior of F1–F12, between their standard and secondary functions. If you disable this option, you cannot toggle dynamically the primary behavior of these keys. The available options are: <ul style="list-style-type: none"><li>· Fn Lock. This option is selected by default.</li><li>· Lock Mode Disable/Standard</li><li>· Lock Mode Enable/Secondary</li></ul>
<b>Fastboot</b>	Allows you to speed up the boot process by bypassing some of the compatibility steps. The options are: <ul style="list-style-type: none"><li>· Minimal</li><li>· Thorough (default)</li><li>· Auto</li></ul>
<b>Extended BIOS POST Time</b>	Allows you to create an additional preboot delay. The options are: <ul style="list-style-type: none"><li>· 0 seconds. This option is enabled by default.</li><li>· 5 seconds</li><li>· 10 seconds</li></ul>
<b>Full Screen Logo</b>	This option will display full screen logo if your image match screen resolution <ul style="list-style-type: none"><li>· Enable Full Screen Logo</li></ul>
<b>Sign of Life Indication</b>	This option will allows system to indicate during POST that the power button press has been acknowledge in a manner the user can either hear or feel. Enable Sign of Life keyboard Backlight Indication (enabled by default)

# Virtualization support screen options

Option	Description
<b>Virtualization</b>	Allows you to enable or disable the Intel Virtualization Technology. Enable Intel Virtualization Technology (default).
<b>VT for Direct I/O</b>	Enables or disables the Virtual Machine Monitor (VMM) from utilizing the additional hardware capabilities provided by Intel® Virtualization technology for direct I/O. Enable VT for Direct I/O - enabled by default.



## Wireless screen options

Option	Description
<b>Wireless Switch</b>	<p>Allows to set the wireless devices that can be controlled by the wireless switch. The options are:</p> <ul style="list-style-type: none"><li>· WLAN</li><li>· Bluetooth</li></ul> <p>All the options are enabled by default.</p>
<b>Wireless Device Enable</b>	<p>Allows you to enable or disable the internal wireless devices.</p> <ul style="list-style-type: none"><li>· WLAN</li><li>· Bluetooth</li></ul> <p>All the options are enabled by default.</p>

## Maintenance screen options

Option	Description
<b>Service Tag</b>	Displays the Service Tag of your computer.
<b>Asset Tag</b>	Allows you to create a system asset tag if an asset tag is not already set. This option is not set by default.
<b>BIOS Downgrade</b>	This controls flashing of the system firmware to previous revisions.
<b>Data Wipe</b>	<p>This field allows users to erase the data securely from all internal storage devices. The following is list of devices affected:</p> <ul style="list-style-type: none"><li>· Internal SATA HDD/SSD</li><li>· Internal M.2 SATA SDD</li><li>· Internal M.2 PCIe SSD</li><li>· Internal eMMC</li></ul>
<b>BIOS Recovery</b>	<p>This field allows you to recover from certain corrupted BIOS conditions from a recover file on the user primary hard drive or an external USB key.</p> <ul style="list-style-type: none"><li>· BIOS Recovery from Hard Drive (enabled by default)</li><li>· BIOS Auto-Recovery</li><li>· Always perform integrity check (disabled by default)</li></ul>

## System Log screen options

Option	Description
<b>BIOS Events</b>	Allows you to view and clear the System Setup (BIOS) POST events.
<b>Thermal Events</b>	Allows you to view and clear the System Setup (Thermal) events.
<b>Power Events</b>	Allows you to view and clear the System Setup (Power) events.

# SupportAssist System Resolution

Option	Description
<b>Auto OS Recovery Threshold</b>	Allows you to control the automatic boot flow for SupportAssist System. Options are: <ul style="list-style-type: none"><li>· Off</li><li>· 1</li><li>· 2 (Enabled by default)</li><li>· 3</li></ul>
<b>SupportAssist OS Recovery</b>	Allows you to recover the SupportAssist OS Recovery (Disabled by default)

## Updating the BIOS in Windows

It is recommended to update your BIOS (System Setup), on replacing the system board or if an update is available. For laptops, ensure that your computer battery is fully charged and connected to a power outlet

**NOTE:** If BitLocker is enabled, it must be suspended prior to updating the system BIOS, and then re-enabled after the BIOS update is completed.

- 1 Restart the computer.
- 2 Go to **Dell.com/support**.
  - Enter the **Service Tag** or **Express Service Code** and click **Submit**.
  - Click **Detect Product** and follow the instructions on screen.
- 3 If you are unable to detect or find the Service Tag, click the **Choose from all products**.
- 4 Choose the **Products** category from the list.

**NOTE:** Choose the appropriate category to reach the product page

- 5 Select your computer model and the **Product Support** page of your computer appears.
- 6 Click **Get drivers** and click **Drivers and Downloads**.  
The Drivers and Downloads section opens.
- 7 Click **Find it myself**.
- 8 Click **BIOS** to view the BIOS versions.
- 9 Identify the latest BIOS file and click **Download**.
- 10 Select your preferred download method in the **Please select your download method below** window, click **Download File**.  
The **File Download** window appears.
- 11 Click **Save** to save the file on your computer.
- 12 Click **Run** to install the updated BIOS settings on your computer.  
Follow the instructions on the screen.

**NOTE:** It is recommended not to update the BIOS version for more than 3 revisions. For example: If you want to update the BIOS from 1.0 to 7.0, then install version 4.0 first and then install version 7.0.

## System and setup password

You can create a system password and a setup password to secure your computer.

Password type	Description
<b>System password</b>	Password that you must enter to log on to your system.



Password type	Description
Setup password	Password that you must enter to access and make changes to the BIOS settings of your computer.

**CAUTION:** The password features provide a basic level of security for the data on your computer.

**CAUTION:** Anyone can access the data stored on your computer if it is not locked and left unattended.

**NOTE:** Your computer is shipped with the system and setup password feature is disabled.

## Assigning a system password and setup password

You can assign a new **System Password** only when the status is in **Not Set**.

To enter the system setup, press F2 immediately after a power-on or re-boot.

- In the **System BIOS** or **System Setup** screen, select **Security** and press Enter.  
The **Security** screen is displayed.
- Select **System Password** and create a password in the **Enter the new password** field.  
Use the following guidelines to assign the system password:
  - A password can have up to 32 characters.
  - The password can contain the numbers 0 through 9.
  - Only lower case letters are valid, upper case letters are not allowed.
  - Only the following special characters are allowed: space, ("), (+), (.), (-), (.), (/), (:), ([), (\), (]), (`).
- Type the system password that you entered earlier in the **Confirm new password** field and click **OK**.
- Press Esc and a message prompts you to save the changes.
- Press Y to save the changes.  
The computer reboots.

## Deleting or changing an existing system and or setup password

Ensure that the **Password Status** is Unlocked (in the System Setup) before attempting to delete or change the existing System and/or Setup password. You cannot delete or change an existing System or Setup password, if the **Password Status** is Locked.

To enter the System Setup, press F2 immediately after a power-on or reboot.

- In the **System BIOS** or **System Setup** screen, select **System Security** and press Enter.  
The **System Security** screen is displayed.
- In the **System Security** screen, verify that **Password Status** is **Unlocked**.
- Select **System Password**, alter or delete the existing system password and press Enter or Tab.
- Select **Setup Password**, alter or delete the existing setup password and press Enter or Tab.

**NOTE:** If you change the System and/or Setup password, re-enter the new password when promoted. If you delete the System and/or Setup password, confirm the deletion when promoted.

- Press Esc and a message prompts you to save the changes.
- Press Y to save the changes and exit from System Setup.  
The computer reboots.

# System specifications

**NOTE:** Offerings may vary by region. The following specifications are only those required by law to ship with your computer. For more information about the configuration of your computer, go to Help and Support in your Windows operating system and select the option to view information about your computer.

Topics:

- [System information](#)
- [Processor](#)
- [Memory](#)
- [Video](#)
- [Audio](#)
- [Communication](#)
- [Ports and connectors](#)
- [Display](#)
- [Keyboard](#)
- [Touchpad](#)
- [Camera](#)
- [Storage](#)
- [Battery](#)
- [AC adppter](#)
- [Physical dimension](#)
- [Environmental](#)

## System information

Feature	Specification
System Chipset	Intel HM175

## Processor

Feature	Specification
Processor type	Intel Kaby Lake -H
L1 cache	Up to 32 KB cache depending on processor type
L2 cache	Up to 256 KB cache depending on processor type
L3 cache	Up to 8 MB cache depending on processor type
Intel Smart cache with Last Level Cache	Up to 8 MB cache depending on processor type



# Memory

Feature	Specification
Type	DDR4 SDRAM
Speed	2400 MHz
Connectors	4
Capacity	4 GB, 8GB, 16 GB
Minimum Memory	4 GB ( 1 x 4GB)
Maximum memory	32 GB

# Video

Feature	Specification
Type	MXM type-A add-in card
Data bus	PCIe x16, Gen3
Video controller and memory:	<ul style="list-style-type: none"><li>• Intel HD Graphics 630</li><li>• NVIDIA GeForce GTX 1050 Graphics with 2GB/4GB GDDR5 vRAM</li><li>• NVIDIA GeForce GTX 1050Ti Graphics with 4GB GDDR5 vRAM</li><li>• NVIDIA GeForce GTX 1060 Graphics with 6GB GDDR5 vRAM</li></ul>

# Audio

Features	Specification
Integrated	dual-channel High-Definition audio

# Communication

Feature	Specification
Ethernet adapter	network interface card capable of 10/100/1000 mb/s communication
Wireless	WLAN options: <ul style="list-style-type: none"><li>• Qualcomm QCA9377 802.11ac Dual Band (1x1) Wireless Adapter+ Bluetooth 4.1</li><li>• Intel Wireless-AC 3165 1x1 802.11AC Wi-Fi + BT 4.2 LE Wireless Card</li><li>• DW1820 2x2 ac 802.11ac+BT4.1</li></ul>

# Ports and connectors

Feature	Specification
Audio	Universal audio jack connector
Network Adapter	one RJ45 connector



USB C connector with Thunderbolt	one (optional)
USB 3.1 with Gen 1 (with PowerShare)	three
Video	HDMI 2.0
Memory card reader	SD 4.0

## Display

Features	Specification
Type	FHD (1920 x 1080)
Size	15.6 inches
Dimensions:	
Height	193.59 mm (7.62 inches)
Width	344.16 mm (13.54 inches)
Diagonal	396.24 mm (15.60 inches)
Active area (X/Y)	FHD (1920 x 1080)
Maximum resolution	FHD (1920 x 1080)
Maximum Brightness	15.6" FHD Anti-Glare LED-backlit —220 nits
Operating angle	0° (closed) to 135°
Refresh rate	60 Hz
Minimum viewing angles:	
Horizontal	FHD (80/80/80/80)
Vertical	FHD (80/80/80/80)

## Keyboard

Features	Specification
Number of keys	<ul style="list-style-type: none"> <li>· United States: 82 keys</li> <li>· United Kingdom: 83 keys</li> <li>· Japan: 105 keys</li> </ul>
Layout	QWERTY/AZERTY/Kanji

## Touchpad

Features	Specification
X/Y position resolution	<ul style="list-style-type: none"> <li>· X: 41.27+-4.13 counts/mm</li> <li>· Y: 38.75+-3.88 counts/mm</li> </ul>



- 1048/984 cpi

<b>Size</b>	Sensor-active area: <ul style="list-style-type: none"><li>· Width: 99.5 mm (3.92 inches)</li><li>· Height: 53 mm (2.09 inches)</li></ul>
<b>Multi-Touch</b>	Configurable single finger and multi-finger gestures

## Camera

Features	Specification
<b>Type</b>	CMOS Sensor
<b>Still Resolution</b>	1280 x 720 Pixels (Maximum)
<b>Video Resolution</b>	1280 x 720 Pixels (Maximum)
<b>Diagonal</b>	74 degrees

## Storage

Features	Specification
<b>Storage:</b>	<ul style="list-style-type: none"><li>· 1 TB 5400 RPM HDD 2.5" (7 mm)</li><li>· 512 GB M.2 2230 PCIe NVMe SSD</li><li>· 500 GB 7200 RPM HDD 2.5" (7 mm)</li><li>· 256 GB M.2 2280 SATA SSD</li><li>· 256 GB M.2 2230 PCIe NVMe SSD</li><li>· 128 GB M.2 2280 SATA SSD</li></ul>

## Battery

Features	Specification
<b>Wattage</b>	56 Whr (4 Cell) Prismatic with ExpressCharge
<b>Type</b>	Li-polymer
<b>Length</b>	233.06 mm (9.170 inches)
<b>Height</b>	5.9 mm (0.232 inches)
<b>Width</b>	90.73 mm (3.572 inches)
<b>Weight</b>	250.00 g
<b>Voltage</b>	15.2 VDC
<b>Life span</b>	<ul style="list-style-type: none"><li>· 300 discharge/charge cycles</li><li>· 1000 discharge/charge cycles (LCL)</li></ul>
<b>Temperature range:</b>	
<b>Operating</b>	<ul style="list-style-type: none"><li>· Charge: 0° C to 50° C (32° F to 158° F)</li></ul>



· Discharge: 0° C to 70° C (32° F to 122° F)

**Non-Operating** -20° C to 65° C (4° F to 149° F)

**Coin-cell battery** 3 V CR2032 lithium ion cell

## AC adpter

Features	Specification
<b>Wattage</b>	180 W
<b>Input voltage</b>	100 VAC to 240 VAC
<b>Input current (maximum)</b>	3.5 A
<b>Input frequency</b>	50 Hz to 60 Hz
<b>Output current</b>	9.23 A (continuous)
<b>Rated output voltage</b>	19.50 VDC
<b>Height</b>	30.4 mm (1.2 inches)
<b>Width</b>	76.2 mm (3.0 inches)
<b>Depth</b>	154.9 mm (6.1 inches)
<b>Weight</b>	0.57 kg (1.25 lb)
<b>Temperature range:</b>	
<b>Operating</b>	0° C to 40° C (32° F to 104° F)
<b>Non-Operating</b>	-40° C to 70° C (-40° F to 158° F)

## Physical dimension

Feature	Specification
<b>Weight (pounds/kilograms)</b>	5.86 lb/2.66 kg
<b>Dimensions</b>	
<b>Height (inches/mm)</b>	
<b>Front</b>	23.95 mm (0.94 inch)
<b>Rear</b>	24.95 mm (0.98 inch)
<b>Width (inches/mm)</b>	389.0 mm (15.31 inch)
<b>Depth (inches/mm)</b>	270.0 mm (10.62 inches)

## Environmental

Feature	Specification
<b>Temperature range:</b>	



<b>Operating</b>	10° C to 35° C (50° F to 95° F)
<b>Storage</b>	-40° C to 65° C (-40° F to 149° F)
<b>Relative humidity (maximum):</b>	
<b>Storage</b>	20% to 80% (non-condensing)
<b>Maximum vibration:</b>	
<b>Operating</b>	5 to 350 Hz at 0.0002 G <sup>2</sup> /Hz
<b>Storage</b>	5 to 500 Hz at 0.001 to 0.01 G <sup>2</sup> /Hz
<b>Maximum shock:</b>	
<b>Operating</b>	40 G +/- 5% with pulse duration of 2 msec +/-10% (equivalent to 51 cm/sec [20 in/sec])
<b>Storage</b>	105 G +/- 5% with pulse duration of 2 msec +/-10% (equivalent to 127 cm/sec [50 in/sec])
<b>Maximum Altitude:</b>	
<b>Operating</b>	-15.2 to 3048 m (-50 to 10,000 ft)
<b>Storage</b>	-15.2 to 10,668 m (-50 to 35,000 ft)



# Software

This chapter details the supported operating systems along with instructions on how to install the drivers.

Topics:

- [Operating system configurations](#)
- [Device drivers](#)

## Operating system configurations

This topic lists the operating system supported by

**Table 8. Operating systems**

Windows 10	<ul style="list-style-type: none"> <li>· Microsoft Windows 10 Home 64 bit</li> <li>· Microsoft Windows10 Professional 64 bit</li> <li>· Microsoft Windows 10 National Academic 64-bit (Bid Desk)</li> </ul>
Others	<ul style="list-style-type: none"> <li>· Ubuntu 16.04 LTS 64-bit</li> </ul>

## Device drivers

This section provides information about Windows 10 drivers. Drivers can be downloaded from the Dell Support website. Most of the device drivers are pre-installed during the Windows installation process. For best results, Dell recommends installing the chipset driver utility first, followed by the rest of the devices' drivers/software packages in any sequence.

**Table 9. Device drivers**

Categories	Driver Name
Chipset Drivers	<a href="#">Intel Chipset</a> <a href="#">Intel Management Engine Interface</a> <a href="#">Intel Serial I/O</a> <a href="#">Intel Dynamic Platform and Thermal Framework Drivers</a> <a href="#">Intel Software Guard Extensions</a> <a href="#">Intel HID Event Filter</a>
Display Drivers	<a href="#">Intel HD Graphics</a>
Audio Driver	<a href="#">Realtek audio driver</a>
Network Drivers	<a href="#">Bluetooth Drivers</a> <a href="#">Realtek Ethernet</a> <a href="#">Realtek Card Reader</a>
Security	<a href="#">Fingerprint Reader</a>



# Intel chipset drivers

Verify if the Intel chipset drivers are already installed in the laptop.

**Table 10. Intel chipset drivers**

## Before installation

- System devices
  - ACPI Fixed Feature Button
  - ACPI Lid
  - ACPI Power Button
  - ACPI Processor Aggregator
  - ACPI Sleep Button
  - ACPI Thermal Zone
  - Composite Bus Enumerator
  - High Definition Audio Controller
  - High precision event timer
  - Intel(R) Power Engine Plug-in
  - Intel(R) Serial IO I2C Host Controller - 9D60
  - Intel(R) Serial IO I2C Host Controller - 9D61
  - Intel(R) Serial IO I2C Host Controller - 9D62
  - Intel(R) Serial IO I2C Host Controller - 9D64
  - Legacy device
  - Microsoft ACPI-Compliant Embedded Controller
  - Microsoft ACPI-Compliant System
  - Microsoft System Management BIOS Driver
  - Microsoft UEFI-Compliant System
  - Microsoft Virtual Drive Enumerator
  - Microsoft Windows Management Interface for ACPI
  - Microsoft Windows Management Interface for ACPI
  - NDIS Virtual Network Adapter Enumerator
  - PCI Express Root Complex
  - PCI standard host CPU bridge
  - PCI standard ISA bridge
  - PCI-to-PCI Bridge
  - PCI-to-PCI Bridge
  - PCI-to-PCI Bridge
  - Plug and Play Software Device Enumerator
  - Programmable interrupt controller
  - Remote Desktop Device Redirector Bus
  - System CMOS/real time clock
  - System timer
  - UMBus Root Bus Enumerator

## After installation

- System devices
  - ACPI Fixed Feature Button
  - ACPI Lid
  - ACPI Power Button
  - ACPI Processor Aggregator
  - ACPI Sleep Button
  - ACPI Thermal Zone
  - Charge Arbitration Driver
  - Composite Bus Enumerator
  - Dell Diag Control Device
  - Dell System Analyzer Control Device
  - High Definition Audio Controller
  - High precision event timer
  - Intel(R) 100 Series/C230 Series Chipset Family LPC Controller (HM175) - A152
  - Intel(R) 100 Series/C230 Series Chipset Family PCI Express Root Port #5 - A114
  - Intel(R) 100 Series/C230 Series Chipset Family PCI Express Root Port #1 - A110
  - Intel(R) 100 Series/C230 Series Chipset Family PCI Express Root Port #6 - A115
  - Intel(R) 100 Series/C230 Series Chipset Family PMC - A121
  - Intel(R) 100 Series/C230 Series Chipset Family SMBus - A123
  - Intel(R) 100 Series/C230 Series Chipset Family Thermal subsystem - A131
  - Intel(R) Management Engine Interface
  - Intel(R) Power Engine Plug-in
  - Intel(R) Serial IO I2C Host Controller - A160
  - Intel(R) Serial IO I2C Host Controller - A161
  - Intel(R) Xeon(R) E3 - 1200 v6/7th Gen Intel(R) Core(TM) Host Bridge/DRAM Registers - 5910
  - Intel(R) Xeon(R) E3 - 1200/1500 v5/6th Gen Intel(R) Core(TM) PCIe Controller (x16) - 1901
  - Legacy device
  - Microsoft ACPI-Compliant Embedded Controller
  - Microsoft ACPI-Compliant System

# Intel management engine interface

Verify if the Intel management engine interface drivers are already installed in the laptop.



**Table 11. Intel management engine interface**

**Before installation**

- Other devices
  - Broadcom NFP
  - Broadcom USB w/touch sensor
  - Network Controller
  - PCI Data Acquisition and Signal Processing Controller
  - PCI Data Acquisition and Signal Processing Controller
  - PCI Device
  - PCI Memory Controller
  - PCI Serial Port
  - PCI Simple Communications Controller**
  - SMBus Controller

**After installation**

- System devices
  - ACPI Fixed Feature Button
  - ACPI Lid
  - ACPI Power Button
  - ACPI Processor Aggregator
  - ACPI Sleep Button
  - ACPI Thermal Zone
  - Charge Arbitration Driver
  - Composite Bus Enumerator
  - Dell Diag Control Device
  - Dell System Analyzer Control Device
  - High Definition Audio Controller
  - High precision event timer
  - Intel(R) 100 Series/C230 Series Chipset Family LPC Controller (HM175) - A152
  - Intel(R) 100 Series/C230 Series Chipset Family PCI Express Root Port #5 - A114
  - Intel(R) 100 Series/C230 Series Chipset Family PCI Express Root Port #1 - A110
  - Intel(R) 100 Series/C230 Series Chipset Family PCI Express Root Port #6 - A115
  - Intel(R) 100 Series/C230 Series Chipset Family PMC - A121
  - Intel(R) 100 Series/C230 Series Chipset Family SMBus - A123
  - Intel(R) 100 Series/C230 Series Chipset Family Thermal subsystem - A131
  - Intel(R) Management Engine Interface
  - Intel(R) Power Engine Plug-in
  - Intel(R) Serial IO I2C Host Controller - A160
  - Intel(R) Serial IO I2C Host Controller - A161
  - Intel(R) Xeon(R) E3 - 1200 v6/7th Gen Intel(R) Core(TM) Host Bridge/DRAM Registers - 591C
  - Intel(R) Xeon(R) E3 - 1200/1500 v5/6th Gen Intel(R) Core(TM) PCIe Controller (x16) - 1901
  - Legacy device
  - Microsoft ACPI-Compliant Embedded Controller
  - Microsoft ACPI-Compliant System
  - Microsoft System Management BIOS Driver
  - Microsoft UEFI-Compliant System
  - Microsoft Virtual Drive Enumerator

## Intel Serial Input Output

Verify if the Intel Serial I/O driver is already installed in the system, by referring to the illustration below.



**Table 12. Intel Serial Input Output**

**Before installation**

- System devices
  - ACPI Fixed Feature Button
  - ACPI Lid
  - ACPI Power Button
  - ACPI Processor Aggregator
  - ACPI Sleep Button
  - ACPI Thermal Zone
  - Composite Bus Enumerator
  - High Definition Audio Controller
  - High precision event timer
  - Intel(R) Power Engine Plug-in
  - Intel(R) Serial IO I2C Host Controller - 9D60
  - Intel(R) Serial IO I2C Host Controller - 9D61
  - Intel(R) Serial IO I2C Host Controller - 9D62
  - Intel(R) Serial IO I2C Host Controller - 9D64
  - Legacy device
  - Microsoft ACPI-Compliant Embedded Controller
  - Microsoft ACPI-Compliant System
  - Microsoft System Management BIOS Driver
  - Microsoft UEFI-Compliant System
  - Microsoft Virtual Drive Enumerator
  - Microsoft Windows Management Interface for ACPI
  - Microsoft Windows Management Interface for ACPI
  - NDIS Virtual Network Adapter Enumerator
  - PCI Express Root Complex
  - PCI standard host CPU bridge
  - PCI standard ISA bridge
  - PCI-to-PCI Bridge
  - PCI-to-PCI Bridge
  - PCI-to-PCI Bridge
  - Plug and Play Software Device Enumerator
  - Programmable interrupt controller
  - Remote Desktop Device Redirector Bus
  - System CMOS/real time clock
  - System timer
  - USB Root Bus Enumerator

**After installation**

- System devices
  - ACPI Fixed Feature Button
  - ACPI Lid
  - ACPI Power Button
  - ACPI Processor Aggregator
  - ACPI Sleep Button
  - ACPI Thermal Zone
  - Charge Arbitration Driver
  - Composite Bus Enumerator
  - Dell Diag Control Device
  - Dell System Analyzer Control Device
  - High Definition Audio Controller
  - High precision event timer
  - Intel(R) 100 Series/C230 Series Chipset Family LPC Controller (HM175) - A152
  - Intel(R) 100 Series/C230 Series Chipset Family PCI Express Root Port #5 - A114
  - Intel(R) 100 Series/C230 Series Chipset Family PCI Express Root Port #1 - A110
  - Intel(R) 100 Series/C230 Series Chipset Family PCI Express Root Port #6 - A115
  - Intel(R) 100 Series/C230 Series Chipset Family PMC - A121
  - Intel(R) 100 Series/C230 Series Chipset Family SMBus - A123
  - Intel(R) 100 Series/C230 Series Chipset Family Thermal subsystem - A131
  - Intel(R) Management Engine Interface
  - Intel(R) Power Engine Plug-in
  - Intel(R) Serial IO I2C Host Controller - A160
  - Intel(R) Serial IO I2C Host Controller - A161
  - Intel(R) Xeon(R) E3 - 1200 v6/7th Gen Intel(R) Core(TM) Host Bridge/DRAM Registers - 5910
  - Intel(R) Xeon(R) E3 - 1200/1500 v5/6th Gen Intel(R) Core(TM) PCIe Controller (x16) - 1901
  - Legacy device

## Intel dynamic platform and thermal framework drivers

Verify if the Intel dynamic platform and thermal framework drivers are already installed in the laptop.

**Table 13. Intel dynamic platform and thermal framework drivers**

**Before installation**

- Other devices
  - Network Controller
  - PCI Data Acquisition and Signal Processing Controller
  - PCI Device
  - PCI Device
  - Unknown device
  - Unknown device
  - Unknown device
  - Unknown device
  - Unknown device
  - Unknown device
  - Unknown device
  - Unknown device

**After installation**

- Intel(R) Dynamic Platform and Thermal Framework
  - Intel(R) Dynamic Platform and Thermal Framework Generic Participant
  - Intel(R) Dynamic Platform and Thermal Framework Generic Participant
  - Intel(R) Dynamic Platform and Thermal Framework Generic Participant
  - Intel(R) Dynamic Platform and Thermal Framework Manager
  - Intel(R) Dynamic Platform and Thermal Framework Memory Participant
  - Intel(R) Dynamic Platform and Thermal Framework Processor Participant

## Intel software guard extensions

There is no visible change in the Device Manager after the Software Guard Extensions driver is installed.

Before you can install this driver, Intel Software Guard Extensions must be enabled in BIOS.



# Intel HID event filter

Verify if the Intel HID event filter driver are already installed in the laptop.

**Table 14. Intel HID event filter**

### Before installation

- Human Interface Devices
  - HID-compliant vendor-defined device
  - HID-compliant vendor-defined device
  - I2C HID Device

### After installation

- Human Interface Devices
  - Converted Portable Device Control device
  - HID-compliant consumer control device
  - HID-compliant system controller
  - HID-compliant touch pad
  - HID-compliant vendor-defined device
  - HID-compliant wireless radio controls
  - I2C HID Device
  - Intel(R) HID Event Filter
  - Microsoft Input Configuration Device
  - Portable Device Control device
  - USB Input Device

# Intel HD Graphics

Verify if the Intel HD Graphics driver is already installed in the system, by referring to the illustration below.

**Table 15. Intel HD Graphics**

### Before installation

- Display adapters
  - Microsoft Basic Display Adapter
  - Microsoft Basic Display Adapter

### After installation

- Display adapters
  - Intel(R) HD Graphics 630
  - NVIDIA GeForce GTX 1050 Ti

# Realtek audio driver

Verify if the Realtek audio driver are already installed in the laptop.

**Table 16. Realtek audio driver**

### Before installation

- Sound, video and game controllers
  - High Definition Audio Device
  - High Definition Audio Device

### After installation

- Sound, video and game controllers
  - Intel(R) Display Audio
  - NVIDIA Virtual Audio Device (Wave Extensible) (WDM)
  - Realtek Audio

# Bluetooth drivers

This platform supports a variety of Bluetooth drivers. The following is an example.



**Table 17. Bluetooth drivers**

**Before installation**

**After installation**



## Intel Ethernet controller drivers

Verify if the Intel ethernet controller drivers are already installed in the laptop. There is no visible change before and after installation

**Table 18. Intel Ethernet controller drivers**

**Before installation**

**After installation**

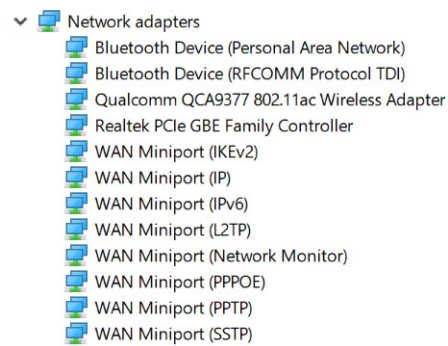
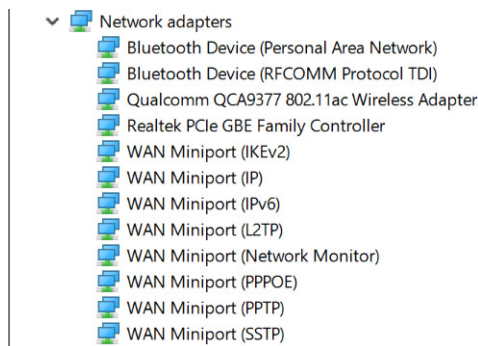

## RealTek card reader drivers

Verify if the RealTek card reader drivers are already installed in the laptop.

**Table 19. RealTek card reader drivers**

**Before installation**

**After installation**

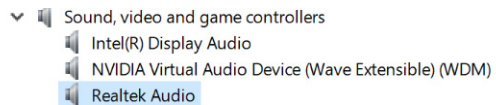
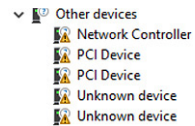

## Fingerprint Reader

Verify if the Fingerprint Reader driver is already installed in the system, by referring to the illustration below.

**Table 20. Fingerprint Readers**

**Before installation**

**After installation**



# Troubleshooting

## Enhanced Pre-Boot System Assessment — ePSA diagnostics

The ePSA diagnostics (also known as system diagnostics) performs a complete check of your hardware. The ePSA is embedded with the BIOS and is launched by the BIOS internally. The embedded system diagnostics provides a set of options for particular devices or device groups allowing you to:

- Run tests automatically or in an interactive mode
- Repeat tests
- Display or save test results
- Run thorough tests to introduce additional test options to provide extra information about the failed device(s)
- View status messages that inform you if tests are completed successfully
- View error messages that inform you of problems encountered during testing

**⚠ CAUTION: Use the system diagnostics to test only your computer. Using this program with other computers may cause invalid results or error messages.**

**ℹ NOTE: Some tests for specific devices require user interaction. Always ensure that you are present at the computer terminal when the diagnostic tests are performed.**

### Running the ePSA diagnostics

- 1 Power-on the computer.
- 2 As the computer boots, press the F12 key as the Dell logo appears.
- 3 On the boot menu screen, select the **Diagnostics** option.
- 4 Click the arrow key at the bottom left corner.  
Diagnostics front page is displayed.
- 5 Press the arrow in the lower-right corner to go to the page listing.  
The items detected are listed.
- 6 To run a diagnostic test on a specific device, press Esc and click **Yes** to stop the diagnostic test.
- 7 Select the device from the left pane and click **Run Tests**.
- 8 If there are any issues, error codes are displayed.  
Note the error code and validation number and contact Dell.

### Diagnostic LED

This section details the diagnostic features of the battery LED in a notebook.

Instead of beep codes errors are indicated via the bicolor Battery Charge LED. A specific blink pattern is followed by flashing a pattern of flashes in amber, followed by white. The pattern then repeats.

**ℹ NOTE: The diagnostic pattern will consist of a two digit number being represented by a first group of LED blinks (1 through 9) in amber, followed by a 1.5 second pause with the LED off, and then a second group of LED blinks (1 through 9) in white. This is then followed by a three second pause, with the LED off, before repeating over again. Each LED blink takes 0.5 seconds.**



The system will not shutdown when displaying the Diagnostic Error Codes. Diagnostic Error Codes will always supersede any other use of the LED. For instance, on Notebooks, battery codes for Low Battery or Battery Failure situations will not be displayed when Diagnostic Error Codes are being displayed:

**Table 21. LED pattern**

Blinking pattern		Problem Description	Suggested Resolution
<b>Amber</b>	<b>White</b>		
2	1	processor	processor failure
2	2	system board, BIOS ROM	system board, covers BIOS corruption or ROM error
2	3	memory	no memory/no RAM detected
2	4	memory	memory failure/RAM failure
2	5	memory	invalid memory installed
2	6	system board; chipset	system board/ chipset error
2	7	display	display failure
3	1	RTC power failure	coin-cell battery failure
3	2	PCI/Video	PCI/Video card/chip failure
3	3	BIOS recovery 1	recovery image not found
3	4	BIOS recovery 2	recovery image found but invalid

## Battery status lights

If the computer is connected to an electrical outlet, the battery light operates as follows:

<b>Alternately blinking amber light and white light</b>	An unauthenticated or unsupported non-Dell AC adapter is attached to your laptop.
<b>Alternately blinking amber light with steady white light</b>	Temporary battery failure with AC adapter present.
<b>Constantly blinking amber light</b>	Fatal battery failure with AC adapter present.
<b>Light off</b>	Battery in full charge mode with AC adapter present.
<b>White light on</b>	Battery in charge mode with AC adapter present.

## Dell Docking Solution

### Thunderbolt 3 Type-C port does not support certain docking systems features

The Vostro 15-7570 system do not support all of the Dell Docking solution features of the Dell Thunderbolt Dock TB16, Dell Dock WD15, Dell Universal Dock D6000, as well as third-party docking solutions features.

**NOTE:** The Dell Power Manager (DPM V3.0) will pop up an alert message informing you of this issue.

**Table 22. Dell Docking solution features not supported**

Features	Description
Power Delivery	Allows Dell Docks (Thunderbolt Dock TB16 / Dell Dock WD15/ Dell Universal Dock D6000) to provide power input through the Type-C connector.
Power/ Wake on dock button	Ability to power on laptops by using the dock button (Dell Thunderbolt Dock TB16 and Dell Dock WD15)
Port Disablement	Allows IT managers to turn off ports in the dock for securing confidential information (Dell Thunderbolt Dock TB16 and Dell Dock WD15)
Error Message and Dock Event Notifications	User will be notified when an insufficient power adapter or cable is paired with the dock and advised to use the recommended accessory. Notifications of firmware updates and port disablement. Examples include Wake on LAN and LAN Cable detect (Dell Thunderbolt Dock TB16 and Dell Dock WD15)
Wake on dock attached	Dock will power on the system automatically (Dell Thunderbolt Dock TB16 and Dell Dock WD15)
Cable FW updates	Ability to receive future enhancements or fixes from Dell (Dell Thunderbolt Dock TB16 and Dell Dock WD15)
Cable LED	Indicates dock connection status (Dell Thunderbolt Dock TB16 and Dell Dock WD15)
Run Time MAC address Overwrite	Bypasses the docking MAC address so IT professionals can identify the user by the notebook/Tablet MAC address and not the common address in the docking stations (Dell Thunderbolt Dock TB16 and Dell Dock WD15)
Dock firmware updates	Ability to receive future enhancements or fixes from Dell (Dell Thunderbolt Dock TB16 and Dell Dock WD15)
LAN Cable detection	WLAN/WWAN is auto disabled when LAN is attached to the dock (Dell Thunderbolt Dock TB16 and Dell Dock WD15)

## Third-party docking solutions features

- The Vostro 15-7570 system supports standard Thunderbolt 3 protocol/features on external graphic docks. However, performance has not been validated in many third-party Thunderbolt 3 eGfx docks and so users may experience certain unexpected compatibility issues.

## Hybrid Power

Users may observe certain behaviors when the system is heavily loaded or in certain gaming conditions, such as:

- Battery capacity does not increase even when connected to the power adapter.
- Battery charges slowly when connected to the power adapter.

The hybrid power feature in the Vostro 15-7570 systems enable the battery to output power to the system during heavy loading and in certain gaming conditions to support overall system power demand (as long as battery capacity is above 10 %).

Battery charging will resume immediately as soon as the system exits the heavy loading condition.

